

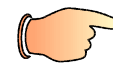

[Table of Contents](#)



User's Manual

Kyocera Laser Printer

FS-680



Caution

NO LIABILITY IS ASSUMED FOR ANY DAMAGE CAUSED BY IMPROPER INSTALLATION.

Notice on Software

SOFTWARE USED WITH THIS PRINTER MUST SUPPORT THE PRINTER'S NATIVE MODE OR ONE OF ITS EMULATION MODES. The printer is factory set to emulate the HP LaserJet 5P. The emulation mode can be changed by following the procedures described in Chapter 2 of the User's Manual (on CD-ROM).

Notice

The information in this manual is subject to change without notification. Additional pages may be inserted in future editions. The user is asked to excuse any technical inaccuracies or typographical errors in the present edition.

No responsibility is assumed if accidents occur while the user is following the instructions in this manual. No responsibility is assumed for defects in the printer's firmware (contents of its read-only memory).

This manual, any copyrightable subject matter sold or provided with or in connection with the sale of the page printer, are protected by copyright. All rights are reserved. Copying or other reproduction of all or part of this manual, any copyrightable subject matter without the prior written consent of Kyocera Corporation is prohibited. Any copies made of all or part of this manual, any copyrightable subject matter must contain the same copyright notice as the material from which the copying is done.

Regarding Tradenames

PRESCRIBE is a registered trademark of Kyocera Corporation. PRESCRIBE 2, PRESCRIBE 2e, KPDL 2, and KIR (Kyocera Image Refinement) are trademarks of Kyocera Corporation.

Diablo 630 is a product of Xerox Corporation. IBM Proprinter X24E is a product of International Business Machines Corporation. Epson LQ-850 is a product of Seiko Epson Corporation. HP LaserJet 5P is a product of Hewlett-Packard Company. Hewlett-Packard, PCL, and P.J.L. are registered trademarks of Hewlett-Packard Company. Centronics is a trade name of Centronics Data Computer Corp. PostScript is a registered trademark of Adobe Systems Incorporated. Macintosh is a registered trademark of Apple Computer, Inc. AppleTalk is a trademark of Apple Computer, Inc. Microsoft, Windows, and MS-DOS are registered trademarks of Microsoft Corporation. Adobe and Acrobat are trademarks of Adobe Systems Incorporated which may be registered in certain jurisdictions.

This Kyocera page printer uses PeerlessPrint5 to provide the HP LaserJet compatible PCL5 language emulation. PeerlessPrint5 is a trademark of The Peerless Group, Redondo Beach, CA 90278, U.S.A.

This product was developed using the Tornado™ Real Time Operating System and Tools from Wind River Systems.

IBM PROGRAM LICENSE AGREEMENT

THE DEVICE YOU HAVE PURCHASED CONTAINS ONE OR MORE SOFTWARE PROGRAMS ("PROGRAMS") WHICH BELONG TO INTERNATIONAL BUSINESS MACHINES CORPORATION ("IBM"). THIS DOCUMENT DEFINES THE TERMS AND CONDITIONS UNDER WHICH THE SOFTWARE IS BEING LICENSED TO YOU BY IBM. IF YOU DO NOT AGREE WITH THE TERMS AND CONDITIONS OF THIS LICENSE, THEN WITHIN 14 DAYS AFTER YOUR ACQUISITION OF THE DEVICE YOU MAY RETURN THE DEVICE FOR A FULL REFUND. IF YOU DO NOT SO RETURN THE DEVICE WITHIN THE 14 DAYS, THEN YOU WILL BE ASSUMED TO HAVE AGREED TO THESE TERMS AND CONDITIONS.

The Programs are licensed not sold. IBM, or the applicable IBM country organization, grants you a license for the Programs only in the country where you acquired the Programs. You obtain no rights other than those granted you under this license.

The term "Programs" means the original and all whole or partial copies of it, including modified copies or portions merged into other programs. IBM retains title to the Programs. IBM owns, or has licensed from the owner, copyrights in the Programs.

1. License

Under this license, you may use the Programs only with the device on which they are installed and transfer possession of the Programs and the device to another party.

If you transfer the Programs, you must transfer a copy of this license and any other documentation to the other party. Your license is then terminated. The other party agrees to these terms and conditions by its first use of the Program.

You may not:

- 1) use, copy, modify, merge, or transfer copies of the Program except as provided in this license;
- 2) reverse assemble or reverse compile the Program; or
- 3) sublicense, rent, lease, or assign the Program.

2. Limited Warranty

The Programs are provided "AS IS".

THERE ARE NO OTHER WARRANTIES COVERING THE PROGRAMS (OR CONDITIONS), EXPRESS OR IMPLIED, INCLUDING, BUT NOT LIMITED TO, THE IMPLIED WARRANTIES OF MERCHANTABILITY AND FITNESS FOR A PARTICULAR PURPOSE.

Some jurisdictions do not allow the exclusion of implied warranties, so the above exclusion may not apply to you.

SUPPLEMENT TO AGREEMENT FOR SOFTWARE BUNDLING AND DISTRIBUTION FOR ALDC

3. Limitation of Remedies

IBM's entire liability under this license is the following;

- 1) For any claim (including fundamental breach), in any form, related in any way to this license, IBM's liability will be for actual damages only and will be limited to the greater of:
 - a) the equivalent of U.S. \$25,000 in your local currency; or
 - b) IBM's then generally available license fee for the Program

This limitation will not apply to claims for bodily injury or damages to real or tangible personal property for which IBM is legally liable.

IBM will not be liable for any lost profits, lost savings, or any incidental damages or other economic consequential damages, even if IBM, or its authorized supplier, has been advised of the possibility of such damages. IBM will not be liable for any damages claimed by you based on any third party claim. This limitation of remedies also applies to any developer of Programs supplied to IBM. IBM's and the developer's limitations of remedies are not cumulative. Such developer is an intended beneficiary of this Section. Some jurisdictions do not allow these limitations or exclusions, so they may not apply to you.

4. General

You may terminate your license at any time. IBM may terminate your license if you fail to comply with the terms and conditions of this license. In either event, you must destroy all your copies of the Program. You are responsible for payment of any taxes, including personal property taxes, resulting from this license. Neither party may bring an action, regardless of form, more than two years after the cause of action arose. If you acquired the Program in the United States, this license is governed by the laws of the State of New York. If you acquired the Program in Canada, this license is governed by the laws of the Province of Ontario. Otherwise, this license is governed by the laws of the country in which you acquired the Program.

Typeface Trademark Acknowledgement

All resident fonts in this printer are licensed from Bitstream Inc., Cambridge, Massachusetts, U.S.A.

Dutch801, Swiss742, Incised901, ZapfCalligraphic801, ZapfHumanist601, OriginalGaramond, and Chianti are trademarks of Bitstream Inc.

Century Schoolbook, Stymie, and Cooper-Black are trademarks of Kingsley-ATF Type Corporation.

ITC ZapfDingbats, ITC Souvenir, ITC Benguiat, and ITC Bookman are registered trademarks of International Type-face Corporation.

Revue is a trademark of Esselte Pendaflex Corporation in the U.S., Letraset Canada Ltd. in Canada, and Esselte Letraset Ltd. elsewhere.

Bitstream Sublicense Agreement

FONTWARE/TrueDoc developed by BITSTREAM INC. is provided as part of this Printer by KYOCERA CORPORATION under license. KYOCERA, as a Licensee of BITSTREAM, grants you, the Sublicensee, non-exclusive right to use FONTWARE/TrueDoc installed in this Printer, if you agree to and at all times comply with the following items:

1. Ownership

As the Sublicensee, you own the Printer in which FONTWARE/TrueDoc is originally installed, but BITSTREAM retains title to and ownership in the software program of FONTWARE/TrueDoc. The Sublicense is not a sale of the original software program of FONTWARE/TrueDoc or any portion or copy of it.

2. Copy Restrictions

FONTWARE/TrueDoc is copyrighted. Unauthorized copying of FONTWARE/TrueDoc even if modified, merged, or included with other software, is expressly forbidden. You may be held legally responsible for any copyright in-fringement.

3. Unauthorized Use

FONTWARE/TrueDoc may not be removed, disclosed and transferred to any third party for any length of time without the prior written consent of KYOCERA or BITSTREAM. Also, you may not modify, adapt, translate, reverse engineer, decompile, or create derivative works based on FONTWARE/TrueDoc.

4. Term

This agreement should remain in full force and effect forever thereby allowing the Sublicensee to use the FONTWARE/TrueDoc forever unless the Sublicensee violates the terms of paragraphs 2. or 3. above. In the event of such violation, this agreement will terminate automatically without notice from KYOCERA. Upon termination, you should destroy FONTWARE/TrueDoc and all copies of them, in part and in whole, including modified copies, if any.

FCC statement

This device complies with Part 15 of the FCC Rules. Operation is subject to the following two conditions: (1) This device may not cause harmful interference, and (2) this device must accept any interference received, including interference that may cause undesired operation.

Note

This equipment has been tested and found to comply with the limits for a Class B digital device, pursuant to Part 15 of the FCC Rules. These limits are designed to provide reasonable protection against harmful interference in a residential installation. This equipment generates, uses, and can radiate radio frequency energy and, if not installed and used in accordance with the instructions, may cause harmful interference to radio communications. However, there is no guarantee that interference will not occur in a particular installation. If this equipment does cause harmful interference to radio or television reception, which can be determined by turning the equipment off and on, the user is encouraged to try to correct the interference by one or more of the following measures:

- Reorient or relocate the receiving antenna.
- Increase the separation between the equipment and receiver.
- Connect the equipment into an outlet on a circuit different from that to which the receiver is connected.
- Consult the dealer or an experienced radio/TV technician for help.

Changes or modifications not expressly approved by the manufacturer for compliance could void the user's authority to operate the equipment.

Shielded circular cable should be used for interfacing with the computer.

Caution to user

Any modification without prior permission may cause harmful interference.

If any modification/change is introduced to this equipment without prior permission, Kyocera as the manufacturer cannot guarantee compliance with FCC rules.

To use equipment which does not comply with FCC rules is prohibited.

The printer may be optionally installed with the following units:

Conforming to the Class B limits

- PK-Series KPD L 2 Upgrade Kit
- IB-10 Serial Interface Board Kit
- PF-16 Paper Feeder (250 sheets)

Interface connectors

Important note on the interface connectors

Be sure to turn off printer power before connecting or disconnecting an interface cable* to the printer. For protection against static discharge which may be applied to the printer's internal electronics through the interface connector(s), keep any interface connector which is not in use capped using the protective cap supplied.

*** Use shielded interface cable.**

Safety information

Laser safety

This printer is certified as a Class 1 laser product under the U.S. Department of Health and Human Services (DHHS) Radiation Performance Standard according to Radiation Control for Health and Safety Act of 1968. This means that the printer does not produce hazardous laser radiation. Since radiation emitted inside the printer is completely confined within protective housings and external covers, the laser beam cannot escape from the printer during any phase of user operation.

Laser notice

This printer is certified in the U.S. to conform to the requirements of DHHS 21 CFR Subchapter for Class I (1) laser products, and elsewhere is certified as a Class I laser product conforming to the requirements of IEC 825.

CAUTION

**LASER RADIATION WHEN OPEN.
DO NOT STARE INTO BEAM OR VIEW DIRECTLY WITH OPTICAL INSTRUMENTS.**



- * Use of controls or adjustments or performance of procedures other than those specified herein may result in hazardous radiation exposure.

KYOCERA FS-680
120V \sim 60Hz 4.3A

KYOCERA CORPORATION
MIE PLANT TAMAKI BLOCK
704-19 NOJINO, TAMAKI-TOWN
WATARAI-COUNTY, MIE PREF. JAPAN
MANUFACTURED : RM

THIS LASER PRODUCT CONFIRMS TO THE APPLICABLE REQUIREMENTS OF FEDERAL REGULATIONS 21 CFR CHAPTER 1, SUBCHAPTER J.

FC Tested To Comply With FCC Standards
FOR HOME OR OFFICE USE 

UL LISTED 8J68 UL 1950  

This device complies with Part 15 of the FCC Rules. Operation is subject to the following two conditions: (1) This device may not cause harmful interference, and (2) this device must accept any interference received, including interference that may cause undesired operation.

This Class B digital apparatus complies with Canadian ICES-003.

Cet appareil numérique de la classe B est conforme à la norme NMB-003 du Canada.

MADE IN JAPAN

(U.S.A./Canada)

KYOCERA FS-680
220-240V \sim 50Hz 2.1A

KYOCERA CORPORATION
MADE IN JAPAN

CLASS 1 LASER PRODUCT TO IEC825
LASER KLASSE 1 NACH IEC825
KLASSE 1 LASER PRODUKT I.H.T. IEC825
LUOKAN 1 LASERLAITE

CE 

ENERGY

ACN003852444

GS 

MADE IN JAPAN

(Europe/Asia)

KYOCERA FS-680
220-240V \sim 50/60Hz 2.1A

KYOCERA CORPORATION
MADE IN JAPAN

CLASS 1 LASER PRODUCT TO IEC825

 

CAUTION
REMOVE POWER CORD BEFORE SERVICE AND FUSE REPLACEMENT.

(Philippines)



DANGER	- INVISIBLE LASER RADIATION WHEN OPEN. AVOID DIRECT EXPOSURE TO BEAM.
ATTENTION	- RAYONNEMENT LASER INVISIBLE EN CAS D'OUVERTURE. EXPOSITION DANGEREUSE AU FAISCEAU.
VORSICHT	- UNSICHTBARE LASERSTRAHLUNG, WENN ABDECKUNG GEÖFFNET. NICHT DEM STRAHL AUSSETZEN.
ATTENZIONE	- RADIAZIONE LASER INVISIBLE IN CASO DI APERTURA. EVITARE L'ESPOSIZIONE AL FASCIO.
PRECAUCION	- RADIACION LASER INVISIBLE CUANDO SE ABRE. EVITAR EXPONERSE AL RAYO.
VARO!	- AVATTAESSA OLET ALTTIINA NÄKYMÄTTÖMÄLLE LASERSÄTEILYLLE. ÄLÄ KATSO SÄTEESEEN.
警告	- このカバーの内部では不可視レーザー光が放射されています。レーザー光にさらされないようにしてください。

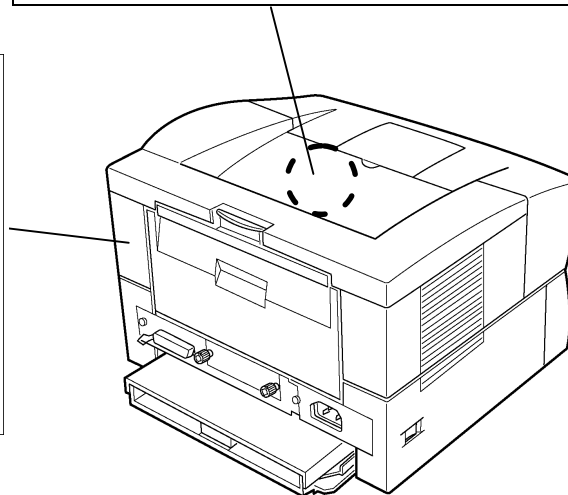

CDRH regulations

The Center of Devices and Radiological Health (CDRH) of the U.S. Food and Drug Administration implemented regulations for laser products on August 2, 1976. These regulations apply to laser products manufactured after August 1, 1976. Compliance is mandatory for products marketed in the United States. A label indicating compliance with the CDRH regulations must be attached to laser products marketed in the United States.

Ozone concentration

The printers generate ozone gas (O₃) which may concentrate in the place of installation and cause an unpleasant smell. To minimize concentration of ozone gas to less than 0.1 ppm, we recommend you not to install the printer in a confined area where ventilation is blocked.

Caution labels

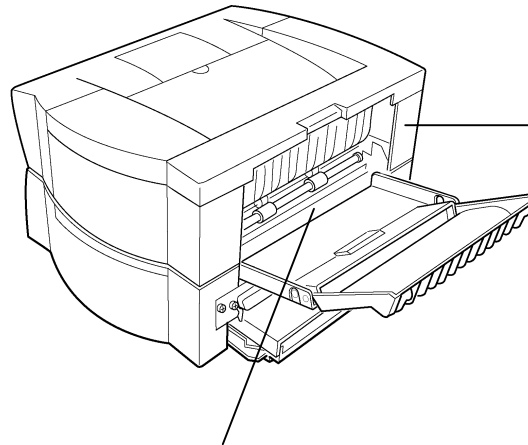

CAUTION
REMOVE POWER CORD BEFORE SERVICE
AND FUSE REPLACEMENT.

VORSICHT
VOR WARTUNG UND SICHERUNGS-
WECHSEL NETZSTECKER ZIEHEN.

ATTENTION
POUR PRÉVENIR LES CHOCS
ÉLECTRIQUES, COUPER L'ALIMENTATION
AVANT DE REMPLACER LE FUSIBLE.

ATENCIÓN
DESENCHUFE EL CORDÓN
DE ALIMENTACIÓN ANTES DEL SERVICIO Y
DEL REEMPLAZO DEL FUSIBLE.

PRECAUZIONE
PRIMA DI CAMBIARE I FIESIBILI O
DI ESEGUIRE RIPARAZIONI,
STACCATTE IL CADO DI ALIMENTAZIONE.



CAUTION
HOT SURFACE
AVOID CONTACT

ACHTUNG
HEISSE OBERFLÄCHE
NICHT BERÜHREN

ATTENTION
TEMPÉRATURE ÉLEVÉE
NE PAS TOUCHER

ATENCIÓN
EXTERIOR CALIENTE
EVITE EL CONTACTO

ATTENZIONE
SUPERFICIE CHE SCOTTA
NON TOCCARE

高温注意

IMPORTANT SAFEGUARDS

1. Read all of these instructions and save these instructions for later use.
2. Unplug this product from the wall outlet before cleaning.
3. Do not use this product near water.
4. Do not place this product on an unstable cart, stand, or table. The product may fall, causing serious damage to the product.
5. Slots and openings in the cabinet and the back are provided for ventilation to ensure reliable operation of the product and to protect it from overheating, these openings must not be blocked or covered. The openings should never be blocked by placing the product on a bed, sofa, rug, or other similar surface. This product should never be placed near or over a radiator or heat register. This product should not be placed in a built-in installation unless proper ventilation is provided.
6. This product is equipped with a 3-wire grounding type plug, a plug having a third (grounding) pin. This plug will only fit into a grounding-type power outlet. This is a safety feature. If you are unable to insert the plug into the outlet, contact your electrician to replace your obsolete outlet. Do not defeat the purpose of the grounding-type plug.
7. Do not allow anything to rest on the power cord. Do not locate this product where persons will walk on the cord.
8. If an extension cord is used with this product, make sure that the total of the ampere ratings on the products plugged into the extension cord do not exceed the extension cord ampere rating.
9. Never push objects of any kind into this product through cabinet slots as they may touch dangerous voltage points or short out parts that could result in a risk of fire or electric shock. Never spill liquid of any kind on the product.
10. Except as explained elsewhere in User's Manual, do not attempt to service this product yourself. Removing covers may expose you to dangerous voltage points or other risks. Refer all servicing in those compartments to service personnel.
11. Unplug this product from the wall outlet and refer servicing to qualified service person-nel under the following conditions:
 - A — When the power cord or plug is damaged or frayed.
 - B — If liquid has been spilled into the product.
 - C — If the product has been exposed to rain or water.
 - D — If the product does not operate normally when the operating instructions are followed. Adjust only those controls that are covered by the operating instructions since improper adjustment of other controls may result in damage and will often require extensive work by a qualified technician to restore the product to normal operation.
 - E — If the product has been dropped or the cabinet has been damaged.

Canadian Department of Communications compliance statement

This Class B digital apparatus meets all requirements of the Canadian Interference-Causing Equipment Regulations.

Avis de conformité aux normes du ministère des Communications du Canada

Cet appareil numérique de la classe B respecte toutes les exigences du Règlement sur le matériel brouilleur du Canada.

ISO 7779

Maschinenlärminformationsverordnung 3. GSGV, 18.01.1991: Der höchste Schalldruckpegel beträgt 70 dB(A) oder weniger gemäß ISO 7779.

CE Marking Directive

according to *Council Directive 89/336/EEC and 73/23/EEC*

Manufacturer's name: Kyocera Corporation, Printer Division
Manufacturer's address: 2-14-9 Tamagawadai, Setagaya Ward, Tokyo 158-8610, Japan

declares that the product

Product name: Page Printer
Model number: FS-680 (as tested with the enhancement optional unit: PF-16 and IB-10)

conforms to the following product specifications.

EN 55 022:1994 Class B
EN 61 000-3-2:1995
EN 61 000-3-3:1995

EN 50 082-1:1992
IEC 801-2:1991
IEC 801-3:1984
IEC 801-4:1988

EN 60 950:1992 (+A1+A2+A3+A4)
EN 60 825-1:1994+A11

The manufacturer and its merchandising companies retain the following technical documentation in anticipation of the inspection that may be conducted by the authorities concerned.

User's instruction that conforms to the applicable specifications
Technical drawings
Descriptions of the procedures that guarantee the conformity
Other technical information

Declaration of Conformity (Australia)

Manufacturer's name: Kyocera Corporation, Printer Division
Manufacturer's address: 2-14-9 Tamagawadai, Setagaya Ward, Tokyo 158-8610, Japan

declares that the product

Product name: Page Printer
Model number: FS-680 (as tested with the enhancement optional unit: PF-16)

Description of device:

The model FS-680 is a 8-ppm, A4 size plain paper supporting page printer, utilizing laser, dry toner, etc. The printer can be equipped with the optional paper feeder model PF-16.

Conforms to the following product specifications.

AS/NZS 3548: 1995 (EN 55 022:1994 Class B)
IEC 60950 (EN 60 950:1992+A1+A2+A3+A4)
IEC 60825-1 (EN 60 825-1:1994+A11)

The manufacturer and its merchandising companies retain the following technical documentation in anticipation of the inspection that may be conducted by the authorities concerned.

User's instruction that conforms to the applicable specifications

Technical drawings

Descriptions of the procedures that guarantee the conformity

Other technical information

KYOCERA ELECTRONICS AUSTRALIA PTY., LTD

Unit 6, 112 Talavera Road,
North Ryde NSW 2113, Australia
Phone: +61 2-9888-9999
Fax: +61 2-9888-9588

Declaration of Conformity (U.S.A.)

Model Number:	FS-680
Trade Name:	Kyocera
Responsible Party:	Kyocera Electronics, Inc.
Address:	11465 John's Creek Parkway Suite #250 Duluth, GA 30097, U.S.A.
Telephone number:	770-623-2150
Fax number:	770-623-2152
Contact person for technical matter:	Paul Bosak
Phone:	770-623-2163

This device complies with Part 15 of the FCC Rules, Operation is subject to the following two conditions: (1) This device may not cause harmful interference, and (2) this device must accept any interference received, including interference that may cause undesired operation.

Safety & EMI Requirements

IEC Laser requirements (U.S.A.)	IEC 60950:1991 (+A1+A2+A3+A4)/(IEC 60825-1:1993) FDA Title 21, CFR Chapter 1, Subchapter J
UL CAN/CSA	UL 1950: 3rd edition CSA C22.2 No.950-95 3rd edition
FCC CDC AS/NZS	Rules 47 CFR, Parts 2 and 15, subpart B, Class B ICES-003 (Issue 3): 1997, Class B AS/NZS 3548: 1995, Class B

Disclaimer

We shall have no liability or responsibility to customers or any other person or entity with respect to any liability, loss or damage caused or alleged to be caused directly or indirectly by equipment sold or furnished by us, including but not limited to, any interruption of service, loss of business or anticipatory profits, or consequential damages resulting from the use or operation of the equipment or software.

Prolonged Non-Use and Moving the Printer

Prolonged Non-use

If you ever leave the printer unused for a long period of time, remove the power cord from the wall outlet.

We recommend you consult with your dealer about the additional actions you should take to avoid possible damages that may occur when the printer is used next time.

Moving the Printer

When you move the printer:

- Move it gently.
- Keep it as level as possible, to avoid spilling toner inside the printer.
- If you ship the printer, remove and ship the process unit separately. Pack the process unit in a plastic bag and ship them separate from the printer itself. Be sure to consult a serviceman before attempting long-distance transportation of the printer.

ENERGY STAR®

As an ENERGY STAR Partner, Kyocera Corporation has determined that this product meets the ENERGY STAR guidelines for energy efficiency.

The basic objective of the ENERGY STAR Program is to reduce environmental pollution by encouraging the manufacture and sale of equipment that uses energy more efficiently.

This printer is equipped with a sleep timer function that conforms with the standards of the ENERGY STAR Program. This function makes it possible to reduce the amount of electrical power consumed by the printer. For maximum power savings, turn off the printer's power supply when not using the printer for extended periods of time.

For details on the sleep timer function and printer power consumption, refer to the CD-ROM instruction manual provided with the printer.

Initial settings of the sleep timer function and power saved using the sleep timer function:

Initial sleep mode setting	Power consumption in sleep mode
15 minutes (30 minutes)	10 W (30 W)

(): ENERGY STAR program guideline

The action program Energy 2000

Energy partnership for a sustainable development. We get further – with all our energy.

KYOCERA ECO-PRODUCT

This product has been developed and manufactured with the express interest of reducing the impact on the environment.

Using Kyocera's innovative cartridge free technology, Kyocera has created an advanced printing system that does not require the wasteful replacement and disposal of a cartridge.

Introduction

The Kyocera laser printer has many extremely desirable features. It was designed to make a contribution to a cleaner environment as well as to represent the latest generation of page printer technology.

Superb print quality

The latest technology from Kyocera such as KIR (Kyocera Image Refinement) function, this laser printer delivers superb print quality and clarity.

Long life modules

The main modules in this laser printer such as the drum, developer unit, and fuser unit, which are disposable in conventional printers, are specifically designed for extraordinarily long life and need no periodic replacement. The only maintenance regularly needed therefore is to replenish the toner supply in the developer approximately every 3,600 printed pages (A4 at a toner coverage of approximately 5%) and to clean some parts inside the printer.

Environmentally benign waste parts

The toner container is made out of a benign, flammable material. (Be sure to dispose of containers according to local laws and regulations.)

Bitmap and scalable typefaces

In addition to its 80 bitmap fonts, the printer provides 45 fully-scalable resident typefaces that are equivalent to HP LaserJet fonts. The scalable typefaces can be used at any size desired up to 999.75 points, in 0.25-point increments.

A new printer control language, PRESCRIBE 2e

PRESCRIBE 2e provides features including advanced graphics capabilities that allow you to print any conceivable outline shape or solid form. Also provided are a variety of special effects, such as patterned fills, gray-scale shading, a user-accessible print image model, and multiple page orientations and print directions within the same page.

PDF417 two-dimensional bar code

The printer includes the capability that allows the user to implement the two-dimensional stacked bar code symbology, PDF417, or Portable Data File 417. This expanded functionality is achieved by using the PRESCRIBE 2e language commands.

Automatic rotation of fonts and graphics

Images and scalable fonts are automatically rotated to match the page orientation.

A wide variety of internal symbol sets

The printer supports most HP LaserJet 5P compatible symbol sets for both bitmap and scalable fonts.

Simple Network Management Protocol (SNMP) compliance

The support for SNMP offers network managers complete open system network management.

Expandable interface

Equipped with a slot for installing optional interface, the interface of this printer can be expanded to meet the operating environment.

Options

The following options are available for this printer.

PF-16	Paper feeder (250-sheet capacity [80g/m ² , 0.11-mm paper thickness])
PK-series	KPDL 2 upgrade kit
IB-10	Serial interface board kit

Contents

Chapter 1 Installing the Page Printer	1-1
Environmental Requirements of the Page Printer	1-2
Unpacking and Inspection.....	1-6
Moving the Printer	1-8
Names of Parts	1-9
Setup and Connections.....	1-11
Expanding Memory	1-32
Chapter 2 Operating the Page Printer	2-1
Control panel.....	2-2
KIR Level.....	2-5
Ecoprint Mode	2-7
Manual Paper Feeding.....	2-8
Chapter 3 Fonts.....	3-1
Fonts	3-2
List of Fonts	3-3
Chapter 4 Maintenance.....	4-1
Toner Container Replacement.....	4-2
Cleaning	4-9

Chapter 5 Troubleshooting	5-1
General Guide.....	5-2
Print Quality Problems	5-4
Indicators.....	5-8
Correcting a Paper Jam	5-12
Appendix A Printer Specifications	A-1
Appendix B Paper Selection	B-1
Appendix C Host Computer Interface	C-1
Appendix D Indicators	D-1
Index	Index-1

Chapter 1

Installing the Page Printer

This chapter uses illustrations to explain the names of parts of this printer, how to use it, its environmental requirements, and how to install it.

Environmental Requirements of the Page Printer	1-2
Unpacking and Inspection	1-6
Moving the Printer.....	1-8
Names of Parts.....	1-9
Setup and Connections	1-11
Expanding Memory.....	1-32

Environmental Requirements of the Page Printer

Places to Avoid

Avoid installing the printer in locations subject to:

- Direct drafts of hot or cold air
- Direct drafts from outside (Avoid locations near doors leading outside.)
- Sudden temperature or humidity changes
- Sources of high temperature, for example, near stoves or radiators
- Excessive dust
- Vibration
- Ammonia or other harmful fumes. (If you are planning to fumigate the room, or make liberal use of insecticide, remove the printer first!)
- Excessive sunlight or humidity
- Lack of ventilation
- Low air pressure, e.g., located more than 2000 meters (6500 feet) above sea level.

Basic requirements

The printer will work best if it is installed in a location that is:

- **Near the computer**
If the parallel interface is used to connect the printer to the computer, the connecting cable should be shielded type and not be longer than 3 meters (10 feet).

- **Level and well supported**
Place the printer on a sturdy table or desk. Do not place the printer on an unstable cart, stand, or table. The printer may fall, causing injury, or serious damage to the printer.
- **Near an AC wall outlet, preferably one that can be used for the printer alone (see section *Power Supply* on next page.)**
- **Only use this printer under the voltage listed on the serial number label attached to the rear panel of the printer.**

Power requirements are:

Voltage	120 V (U.S.A.), 230 V (European countries, Australia) ±10% at each voltage
Frequency	60 Hz (120 V), ±2% 50/60 Hz (230 V), ±2%
Current capacity	Max. 4.3 A at 120 V, or Max. 2.1 A at 230 V

The outlet should be earthed, or an adapter should be used.

If an extension cord is used, the total length of the power cord plus extension should be 5 meters (17 feet) or less.

- **Well ventilated, not too hot or cold, and too damp or dry**

Temperature	10°C to 32.5°C, ideally about 23°C (50°F to 90.5°F, ideally about 73.4°F)
Humidity	20% to 80%, ideally 65%

If you install the printer where the temperature or humidity is outside the above ranges, you may not get the best print quality, and there will be an increased chance of paper jams.

Power Supply

The printer should not be on the same power circuit as an air conditioner, fluorescent light, copier, or shredder, because these devices generate electrical noise on the power line. If it must share a power circuit with equipment like this, a high-frequency noise filter or isolation transformer is advisable. (Filters and transformers are available commercially.)

Avoid using plug multipliers to connect a large number of devices on the same circuit as the printer.

If the power from the outlet itself appears to be unstable, a line stabilizer should be used. In places where the voltage tends to fluctuate, it may be necessary to install a voltage regulator.

As the disconnect device is not incorporated in the printer's AC primary circuit, an easily accessible socket outlet must be provided near the equipment.

Da kein Trennschalter in den Wechselstrom-Primärkreis des Druckers eingebaut ist, muß eine leicht zugängliche Steckdose in der Nähe des Gerätes vorhanden sein.

Grounding

Be sure to connect the ground wire for the printer's power supply to the ground terminal of the power outlet, to a copper pole buried at least 65 cm (25 inches) in the ground, or to a water pipe approved by the water department for use as a ground.

WARNING

Never use a gas pipe as a ground, as this may result in fire.

Surrounding space

Space surrounding the location where the printer is installed is required as shown below for purposes of ventilation and maintenance.

WARNING

Be sure to secure enough space surrounding the printer. Continued use without enough space may cause heat to build up within the printer, resulting in fire.

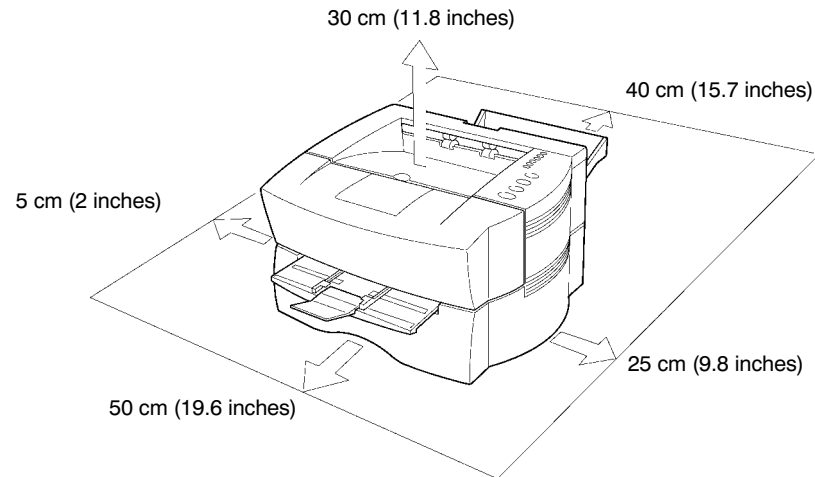

Basic handling precautions

Removing or changing parts other than disposable parts is prohibited. For repairs, contact the Kyocera dealer from which you purchased the printer.

When moving the printer to a new location, contact the Kyocera dealer from which you purchased the printer.

Using this printer to print currency or negotiable bonds is in violation of the law.

Unpacking and Inspection

Remove the printer from the package according to the steps given below. After removing the printer, check that nothing is missing against the list of packaged contents.

1. Place the box containing the printer on a flat, stable surface.
2. Remove the User's Manual, Toner Kit and other items located on top of the spacer and remove the spacer.
3. Carefully remove the printer.

List of packaged contents

Contents of Printer Box

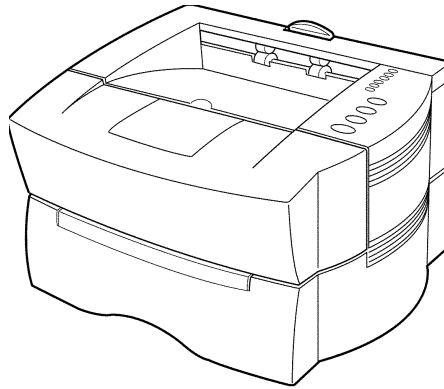

Printer (FS-680)

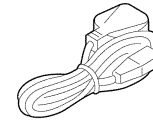

Power Cord

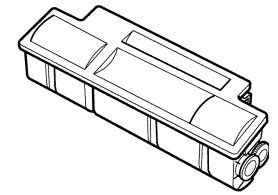

Toner Container (TK-16H)

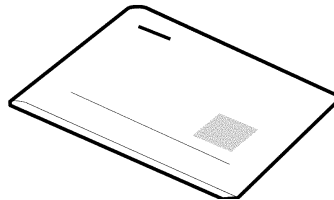

Installation Manual

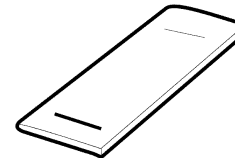

Quick Reference

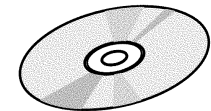

Kyocera Digital Library CD-ROM

Moving the Printer

Note the following items when moving the printer.

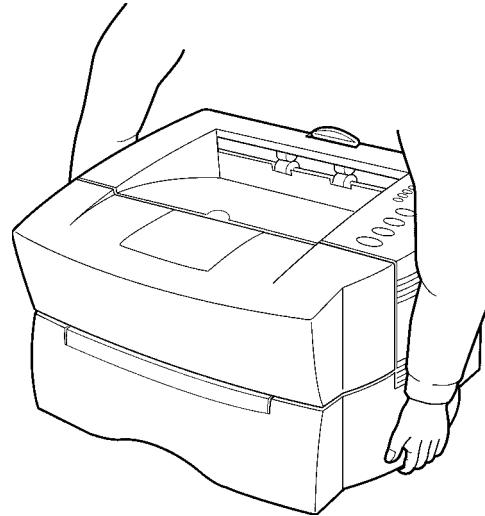

Be sure to lift the printer gently, keeping it horizontal, to prevent toner from soiling the inside of the printer.

Names of Parts

Front View

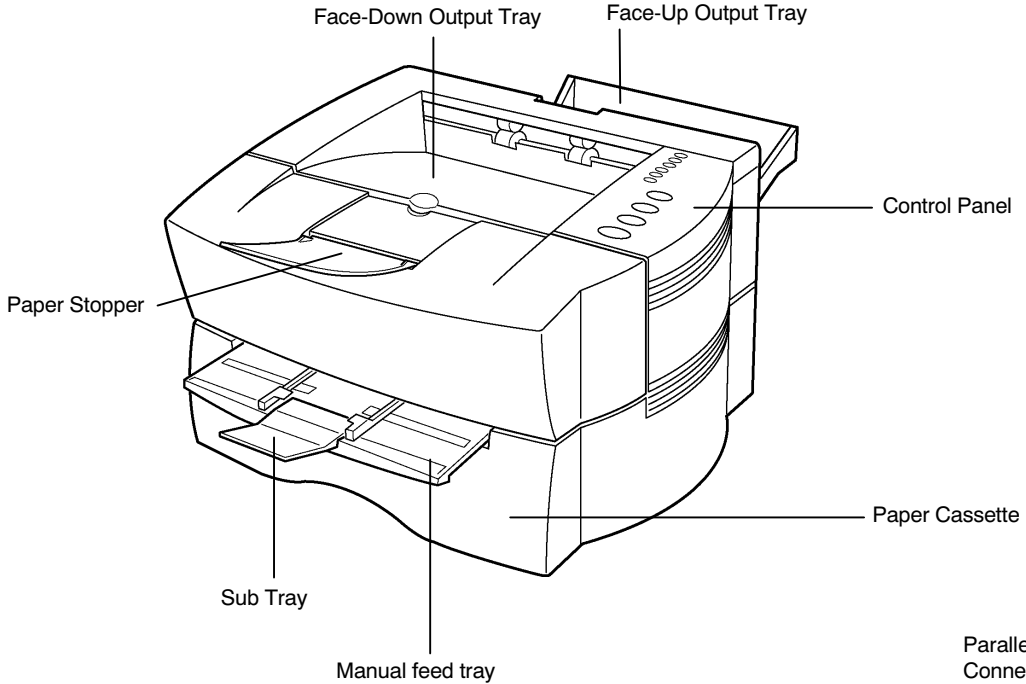

Side View/Rear View

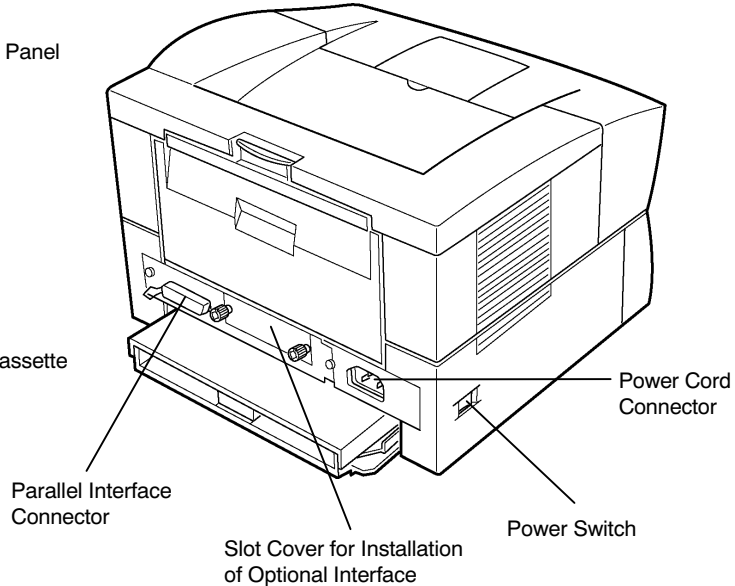

Interior View

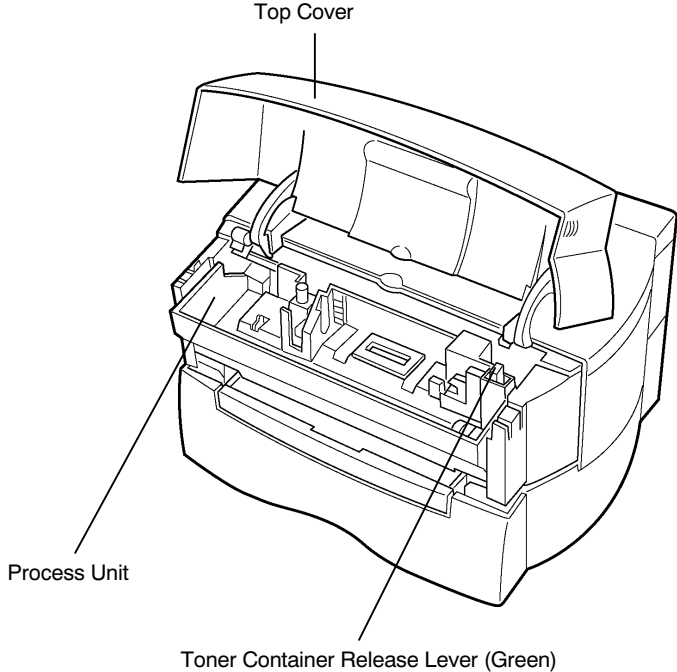

Setup and Connections

Set up the printer according to the following steps.

1. Install the printer on the paper feeder. (Option)(See p.1-12)
2. Remove the process unit protective cover.(See p.1-13)
3. Install the toner container.(See p. 1-15)
4. Close the top cover.(See p.1-16)
5. Add paper.(See p.1-17)
6. Open the paper stopper on the face-down tray.(See p.1-20)
7. Open the face-up output tray (when the tray is being used).(See p.1-20)
8. Connect the printer to the computer.(See p.1-21)
9. Attach the power cord.(See p.1-23)
10. Test the printer.(See p.1-24)
11. Test the interface with the computer.(See p.1-25)
12. Install the printer driver.(See p.1-26)

1. Install the printer on the paper feeder. (Option)

Align the installation holes on the bottom of the printer with the positioning pins on top of the paper feeder and slowly lower the printer into place. Check that the connector on top of the paper feeder is properly connected to the connector on the bottom of the printer.

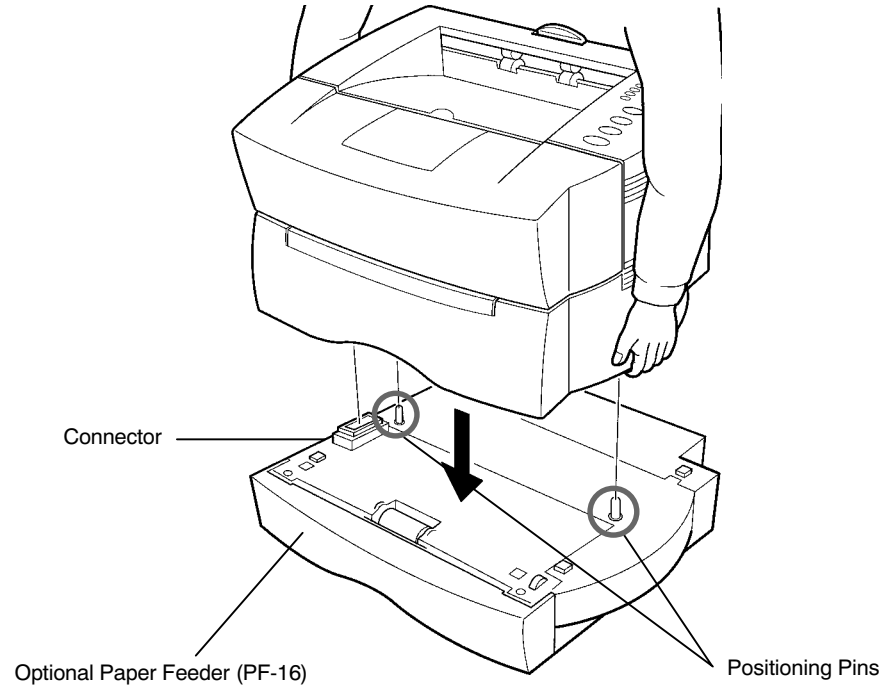

2. Remove the process unit protective cover.

1. Open the printer top cover all the way.

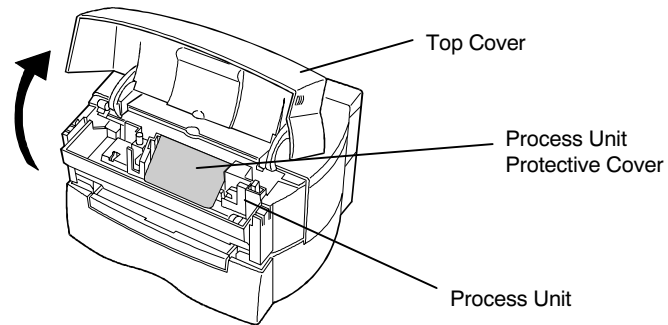

2. Lift the process unit out of the printer. **The drum in the process unit is sensitive to light. Do not expose the drum even to normal office lighting (500lux) for more than five minutes.**

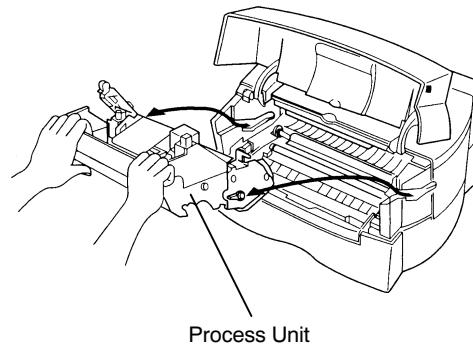

3. Pull and remove the process unit protective cover and give the process unit a horizontal shake of 4 to 5 times.

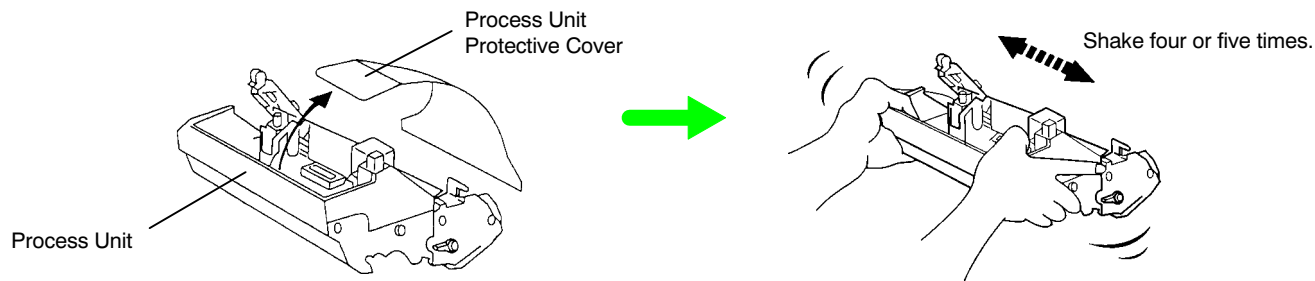

4. Install the process unit in the printer. In doing so, carefully align the guides at the both ends of the process unit properly with the slots in the printer.

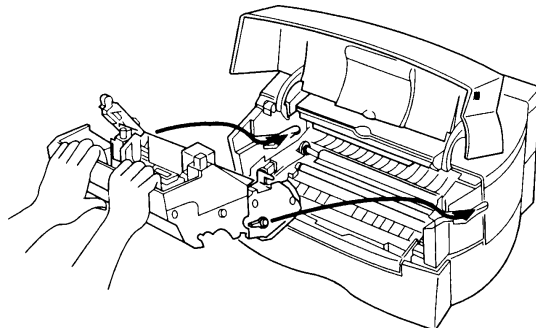

3. Install the toner container.

1. Take the toner container from the bag. Shake the toner container with the protective seal (orange colored) facing up as shown in the figure five times or more to thoroughly mix the toner inside.

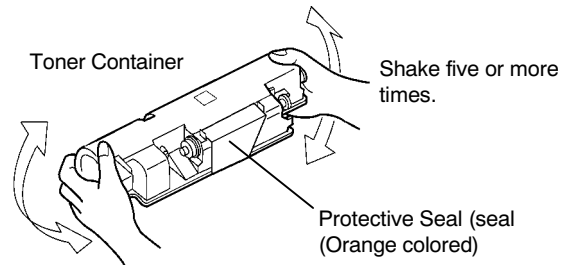

2. Carefully remove the protective seal as shown in the diagram.

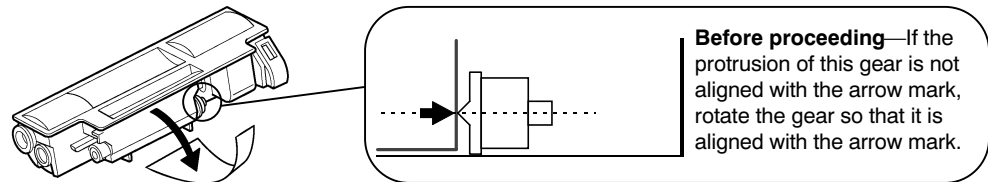

3. Align the ends of the toner container with the grooves to the left and right inside the and install.

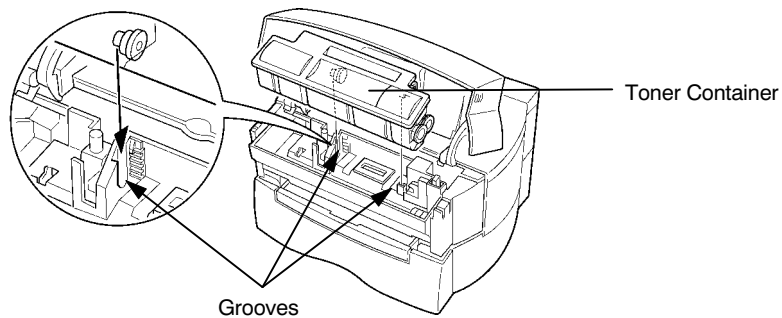

4. Check that the toner container is installed in the correct position, and push forcefully on the top of the toner container at "PUSH HERE."

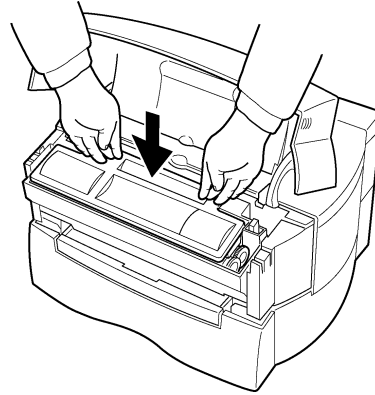

4. Close the top cover.

Close the top cover.

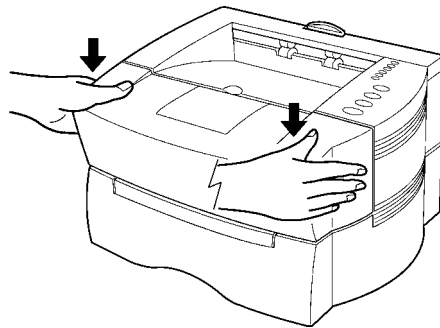

5. Add paper.

Try as much as possible to use fresh paper which has just been opened. Paper which has been stored long periods contains moisture and may result in sheets sticking together and/or paper jams. For specifications on the paper which can be used with this printer, refer to **Appendix B Paper Selection**.

1. Pull the paper cassette all the way out of the printer.

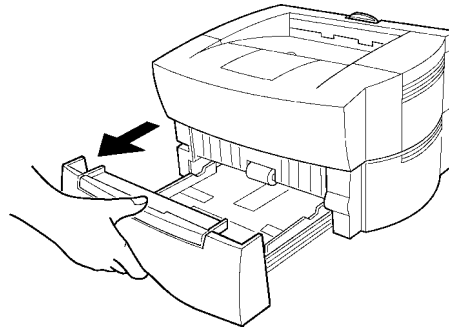

2. Open the cassette cover all the way.

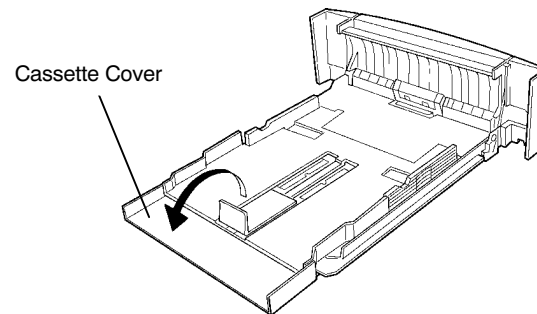

3. Adjust the position of the paper stopper located at the rear of the cassette. While holding up the paper stopper, slide the paper stopper to the desired paper size.

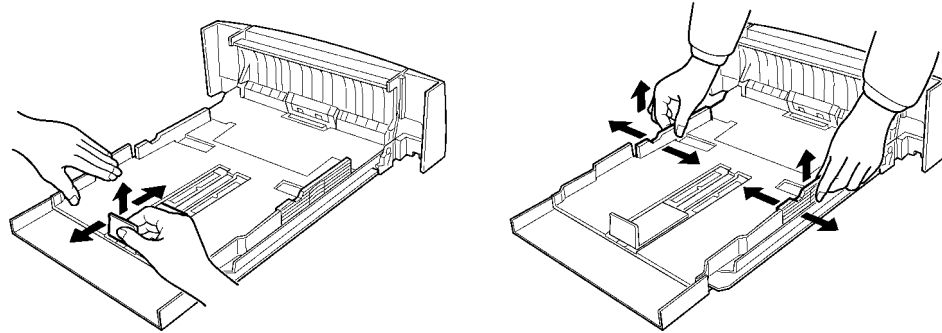

4. Adjust the position of the paper guides located on the left and right side of the cassette. Align the paper guides to the desired paper size by lifting the paper guides so they slide.

Move the side guides inward to where they just touch the edges of the paper.

Do not load more paper than will fit under the load limits on the top of the paper guides. (The cassette will hold approximately 150 sheets of paper with a 80 g/m² (21 lb) basis weight, or with a thickness of 108 microns.)

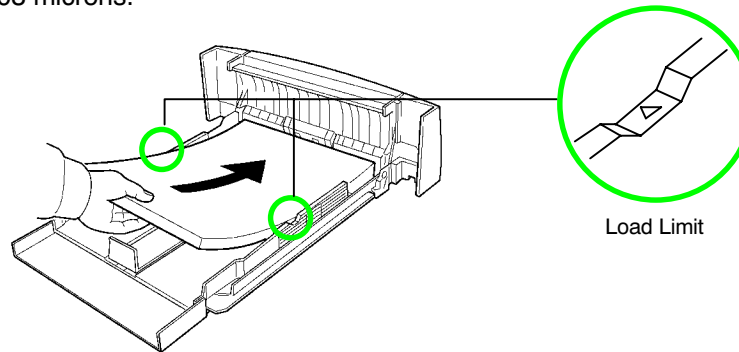

5. Close the cassette cover.

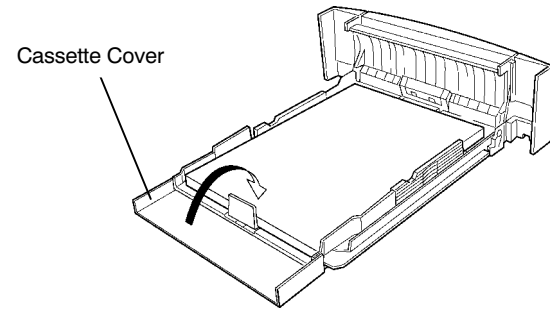

6. Insert the paper cassette into the slot in the printer. Push it straight in as far as it will go.

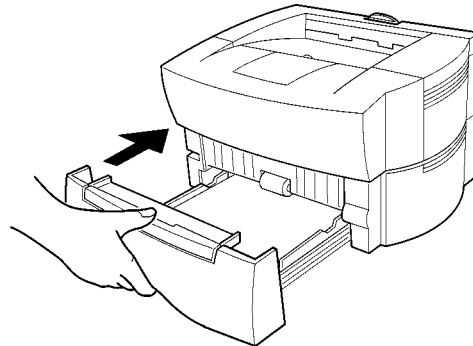

6. Open the paper stopper on the face-down tray.

Raise the paper stopper on the face-down tray as shown in the figure.

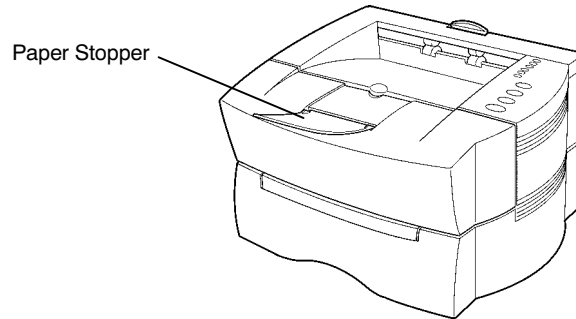

7. Open the face-up output tray (when the tray is being used).

Use the face-up output tray when you wish paper to be stacked with the printed side facing up (reverse order). The face-up output tray is located on the back side of the printer. Use it by opening as shown in the figure.

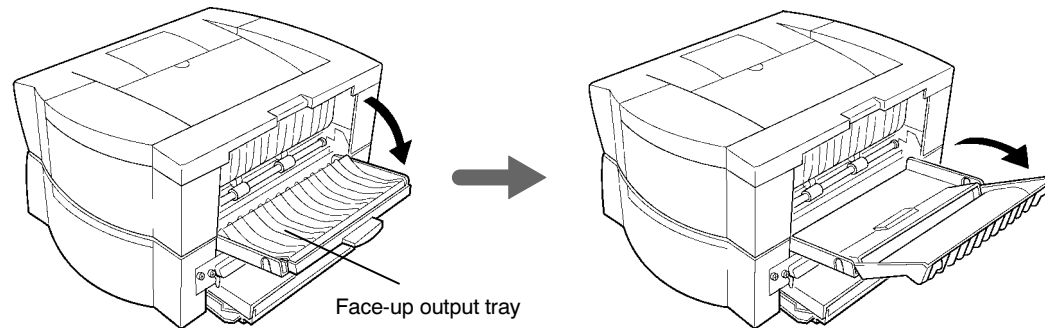

8. Connect the printer to the computer.

CAUTION

Before performing this step, be sure to turn off the printer's power switch and unplug the power plug from the power outlet. Failure to do so may result in electric shock.

A standard Centronics parallel interface connector (🖨️) is located on the rear side of the printer. For pin connections, please refer to **Appendix C**.

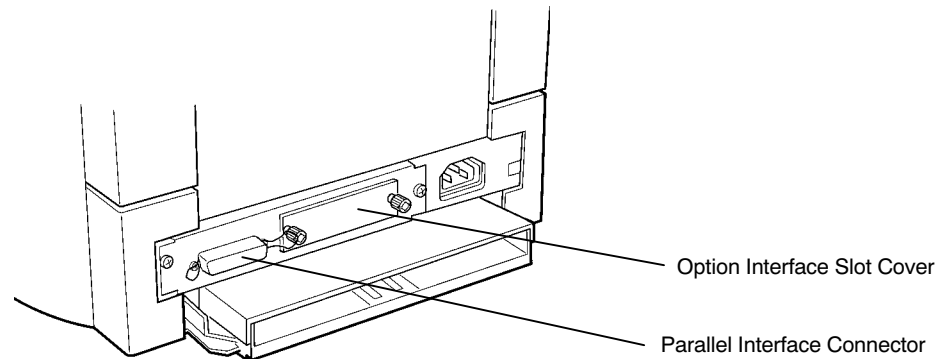

Parallel Interface Connection

1. Plug one end of the printer cable into the connector on the printer marked with a  (parallel) symbol.
2. Close the clips on both sides to fix the connector in place.

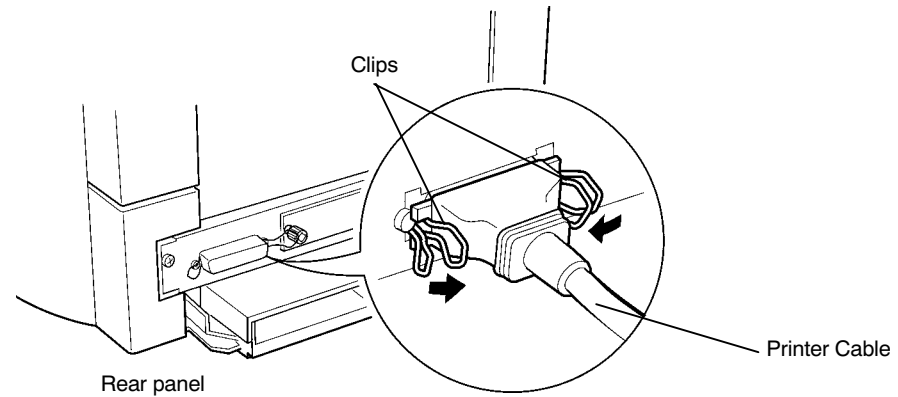

3. Plug the other end of the printer cable into the computer's parallel (Centronics) interface connector. This connector is usually labeled **PRINTER**. For details, refer to the hardware manual for the computer.

9. Attach the power cord.

CAUTION

Be sure the printer's power switch is turned off.

Note

Only use the power cord supplied with the printer.

1. Plug the power cord into the power cord connector on the rear side of the printer.

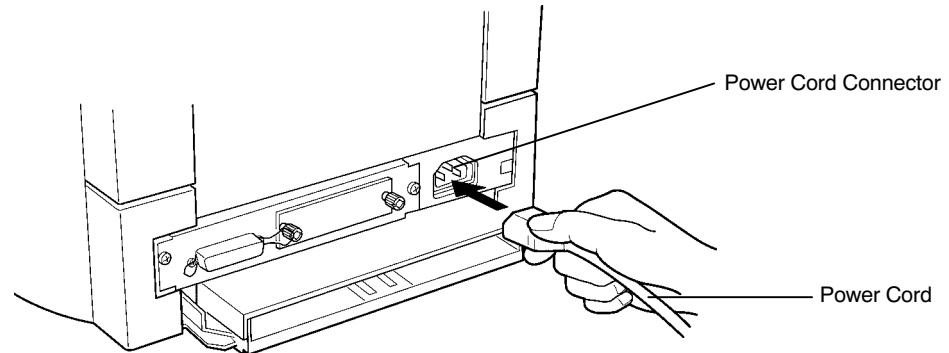

2. Connect the other end of the power cord into a power outlet.

WARNING

Be sure to connect the ground wire of the printer to ground.

10. Test the printer.

Use the following procedure to test the printer and print out a status page indicating factory settings. For details on the indicators and keys on the printer's control panel, please refer to **Chapter 2 The Control Panel**.

1. Turn on the printer's power switch.

It does not matter whether the computer's power is on or off. The six indicators flash in sequence.

Note

Jam indicator flashes unless all covers on the printer are properly closed. If this happens, check that the part indicated in the error message is properly closed. (See **Appendix D**.)

2. Wait until the ON LINE/A4 indicator lights.

If the ON LINE/A4 indicator is off, make it light by pressing the **ON LINE/STATUS** key.

3. Press the **SHIFT** and **ON LINE/STATUS** keys. Information such as the memory allocation, etc., currently set for the printer will be printed on a page in a list.

If the status page prints without problems, you can tell that the developer unit and paper feed cassette are installed properly.

11. Test the interface with the computer.

In order to check that the printer and the computer are properly connected you must print by sending an actual command from the computer.

1. Turn on the printer's power switch and turn on the computer's power as well.
2. Wait until the ON LINE/A4 indicator lights.
3. Enter and execute the following command at the DOS prompt on the computer screen.

```
ECHO !R! STAT; EXIT;> PRN
```

If this causes the printer to print a status page, then the printer and computer are properly connected. If this does not print a status page, check that the printer cable is properly connected. The cable or one of the connectors may also be broken.

Notes on Application Software

The computer and printer have been successfully connected by the procedures up to this point. In order to print from software run on the computer, it is necessary to install a printer driver on the computer to which the printer is connected. After the printer driver is installed, be sure to make proper printer settings from within the software.

12. Install the printer driver.

A CD-ROM containing a printer driver for Windows (Windows 3.1, Windows 95, Windows 98, and Windows NT 3.51/4.0) is supplied with this printer. Once this printer driver is installed on the computer, it is possible to make various settings for this printer from within Windows applications. It is also possible to control options and printing from within Windows.

For each of these operating systems, the printer driver is located in the folder on the CD-ROM. The steps for installing this driver are given below. Read this in conjunction with the manual supplied with Windows.

For details on how to install the printer driver under Windows NT, read the file README.TXT in the CD-ROM's root directory.

Installing Under Windows 95/Windows 98

1. Insert the supplied CD-ROM (Kyocera Digital Library) into the CD-ROM drive of the computer.
2. Click on "Start" with the mouse on the Windows95/ Windows 98 Task Bar, and align the cursor with "Settings." Click on "Printers" among the items displayed.

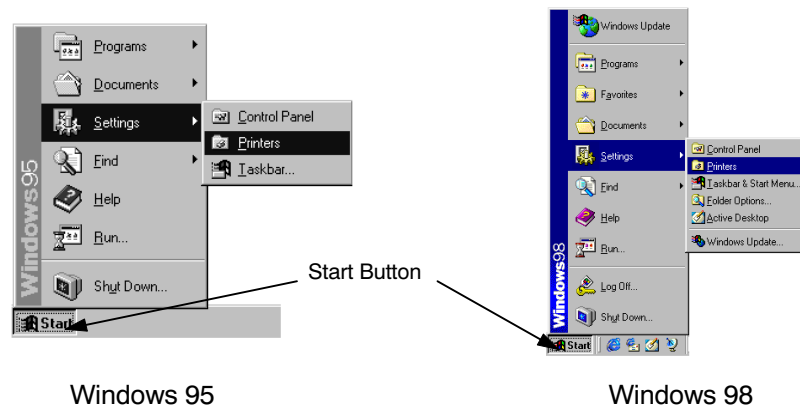

3. The printer folder will open. Double click on “Add printer.”



Windows 95



Windows 98

4. The Printer Wizard screen will appear. Click on “Next >.”
5. A screen for selecting the printer to be either a local printer or network printer will appear. Select the appropriate connection and click on “Next.”
6. Next, “Click the manufacturer and model of your printer...” screen will appear. At this point, select “Have Disk...” located at the lower right. (See the figure for **Step 7**.)
7. Enter “[CD-ROM Drive Name]:\” as the source from which to copy the file and click on “OK.”

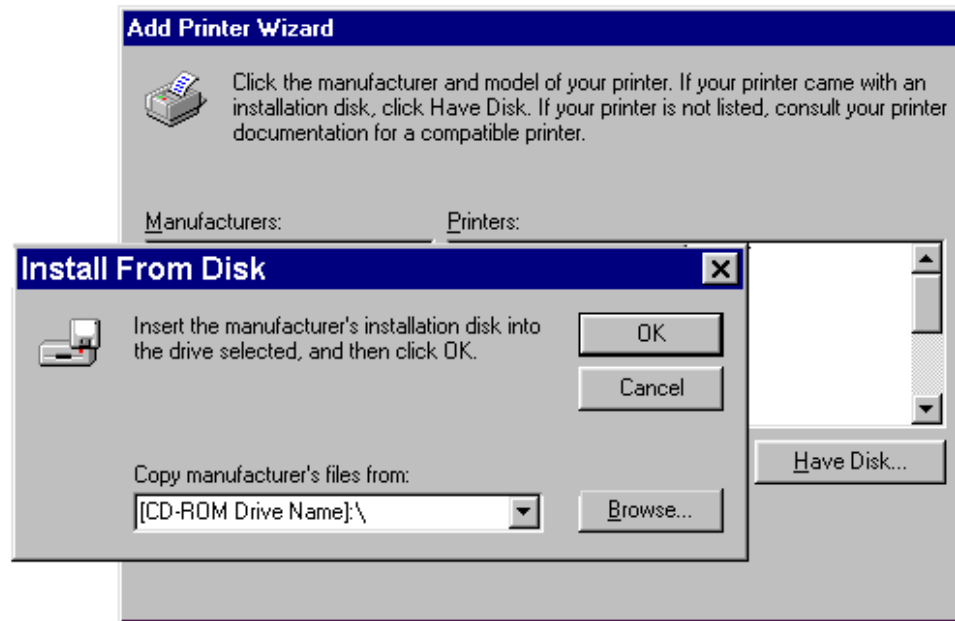

8. Select "Kyocera FS-680," click on "Next >," and follow the on-screen instructions to install. Once the driver has been properly installed, a Kyocera printer icon will be added to the Printers folder.

Note

When printing under Windows 95/Windows 98, be sure to set the emulation of this printer to HP LaserJet 5P (default setting).

Installing Under Windows3.1

1. Insert the supplied CD-ROM into the CD-ROM drive of the computer.
2. Double click on the Control Panel.

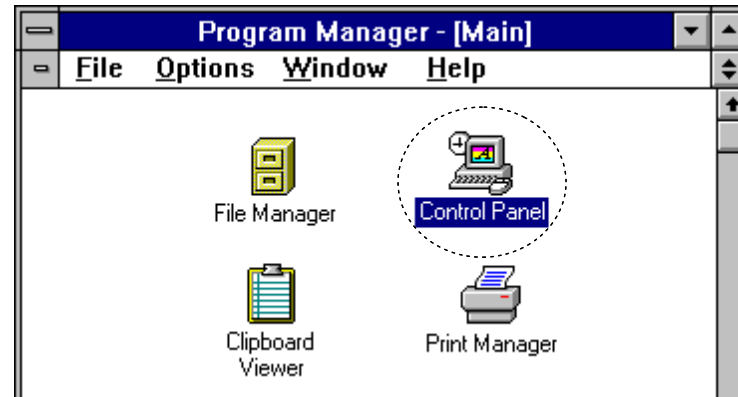

3. Double click on "Printers."

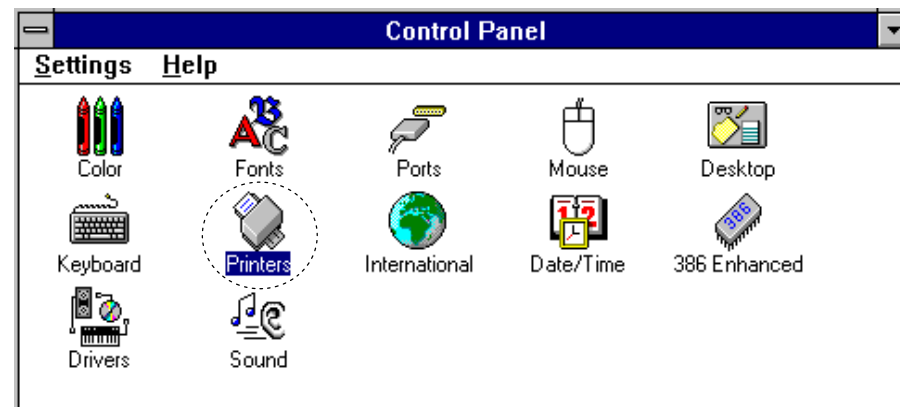

4. Click on "Add >>."
5. A screen for "List of Printers:" will appear. From the choices, click on "Install Unlisted or Updated Printer."

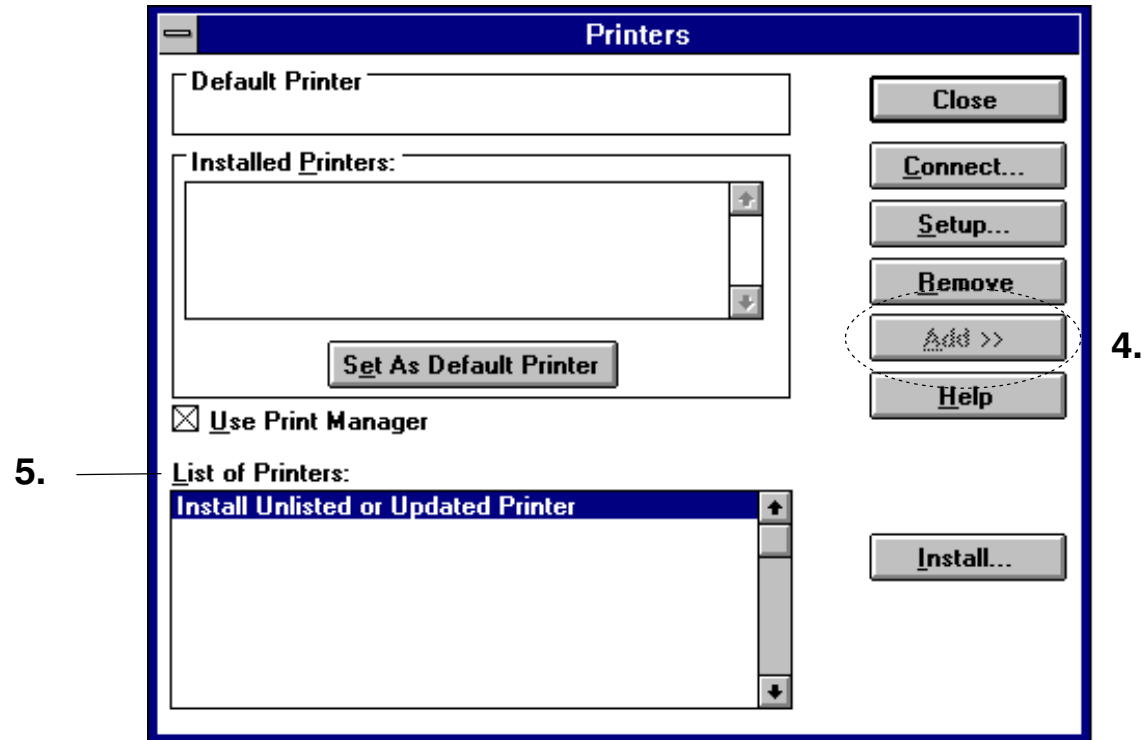

6. Click on “Install...”
7. The Install Driver menu will appear. Enter “[CD-ROM Drive Name]: \” and click on “OK.”

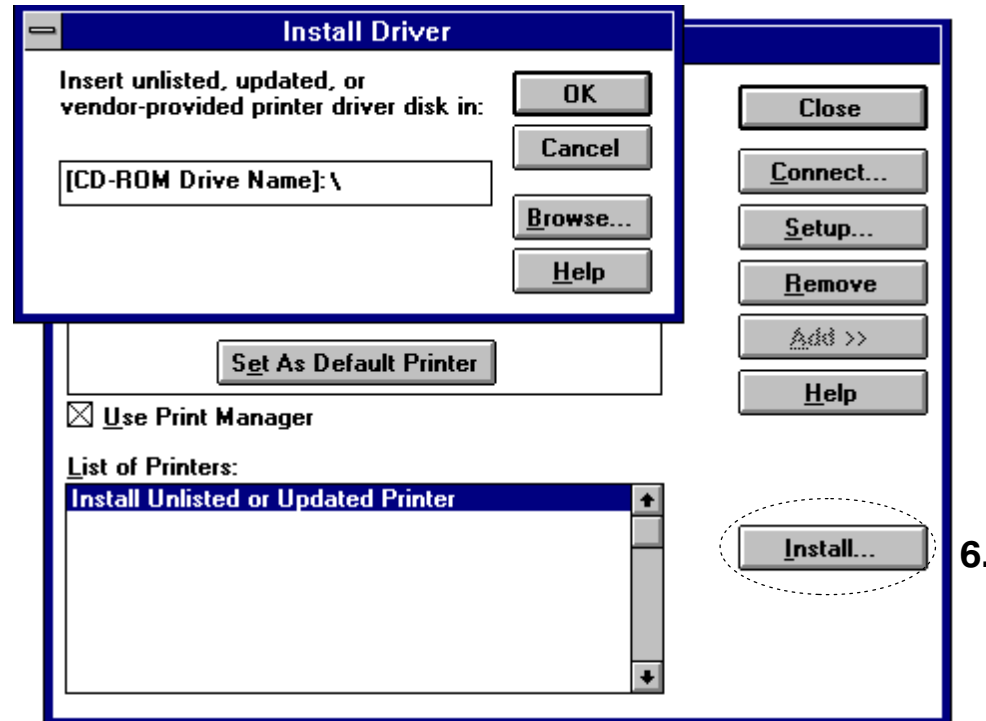

8. Refer to the Readme.txt file at the root directory of the CD-ROM and browse to the directory which contains the appropriate drivers for your country.
9. Select “Kyocera FS-680” from the printers displayed and click on “OK.” Once the driver has been installed, close the Control Panel by clicking on “Close.”

Expanding Memory

The printer comes standard equipped with 4 MB of main memory. However, more complex pages can be printed and processing speed increased by expanding the printer's memory. There is one slot available in the printer for expanding memory. Printer memory can be expanded to up to 36 MB by installing optional extended memory chip (SIMM) in the slot.

Note

The expansion memory should be installed only by a Kyocera authorized dealer or Kyocera certified technician. Kyocera shall not be liable for damage due to improper installation of the expansion memory.

Memory Required by the Printer Environment

It may be necessary to extend memory depending on the operating environment of the printer. Please refer to the table below for minimum memory requirements in various environments.

Printing Environment	Minimum Memory Required	
	Resolution: 300 dpi	Resolution: 600 dpi
HP LaserJet 5P (factory setting)	4 MB	4 MB
HP LaserJet 5P, Resource protection	—	10 MB

The description given below is intended for service personnel.

Precautions on the Handling of Extended SIMM

Static electricity which may accumulate in the human body through walking on carpets or other such surfaces is the enemy of SIMM loaded with many semiconductor chips. Pay attention to the following things before installation to protect memory chips against damage from static electricity.

- Do not remove the SIMM from their anti-static bag until immediately prior to installation.
- Eliminate any static electricity from your body through grounding before touching the SIMM.
- Be absolutely sure when handling the SIMM to hold them by the substrate without touching the printed connector section.

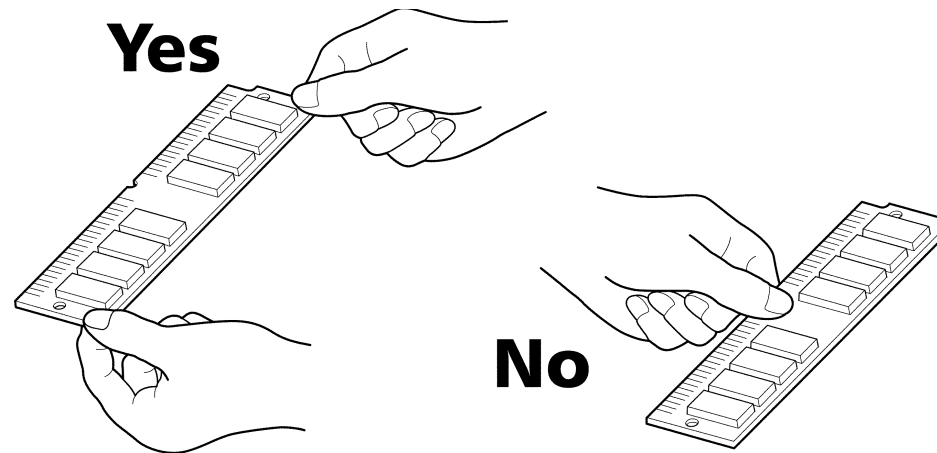

Installing SIMM

Insert the SIMM into the socket on the printer's main board.

WARNING

Take precautions that no foreign substances such as metal chips or liquid get inside the printer during the installation process. Operation of the printer during the presence of a foreign substance may lead to fire or electric shock.

CAUTION

Be sure to turn off the printer's power and disconnect all cables when installing SIMM in the printer. Failure to do so may lead to electric shock.

Draw the main circuit board all way out of the printer as follows:

1. Turn the printer's power off. Unplug the printer's power cable and disconnect it from the host computer.
2. Remove the two screws from the printer's rear cover.

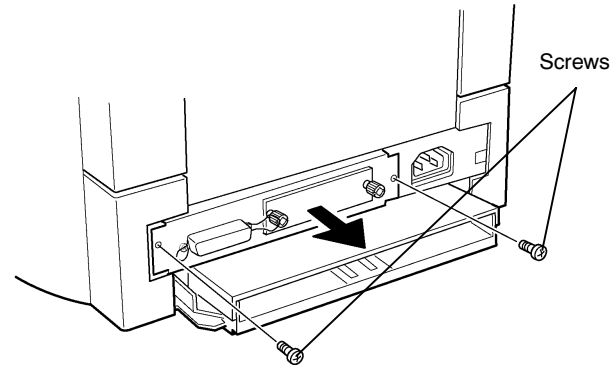

3. Pull the main circuit board all the way out of the printer.

Caution

Before pulling the main board out, clean the area on the table, etc., at the back of the printer's rear panel. Foreign objects, if accidentally stuck to the back of the main board, may cause serious damage to the printer.

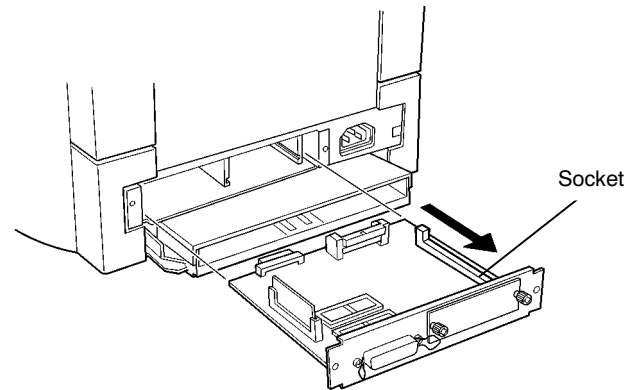

4. Insert the connector end of the SIMM into the socket. Carefully push the board upright until it snaps into place. Make sure that the catches at the ends of the socket fit into the holes at the ends of the SIMM board.

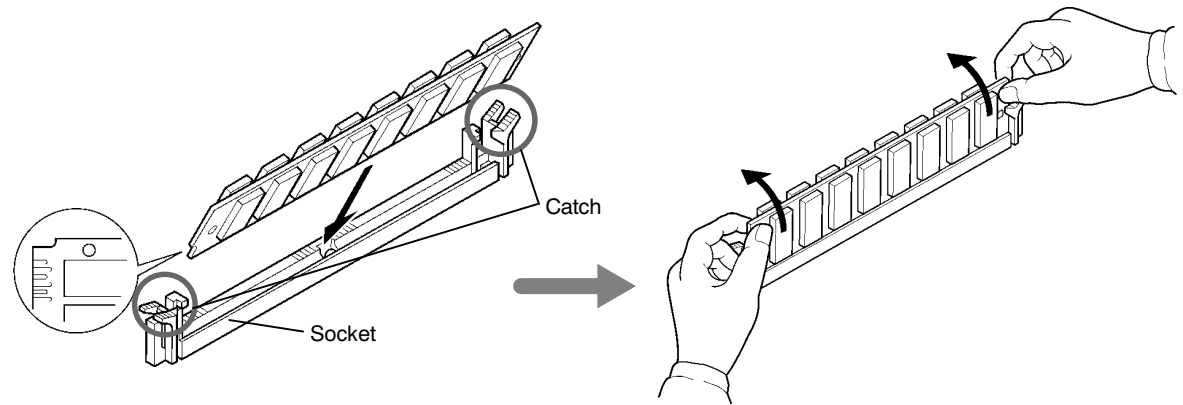

5. To remove the SIMM, carefully pull the end catches sideways slightly and tilt the SIMM to the left as shown, then pull the SIMM out of the socket.

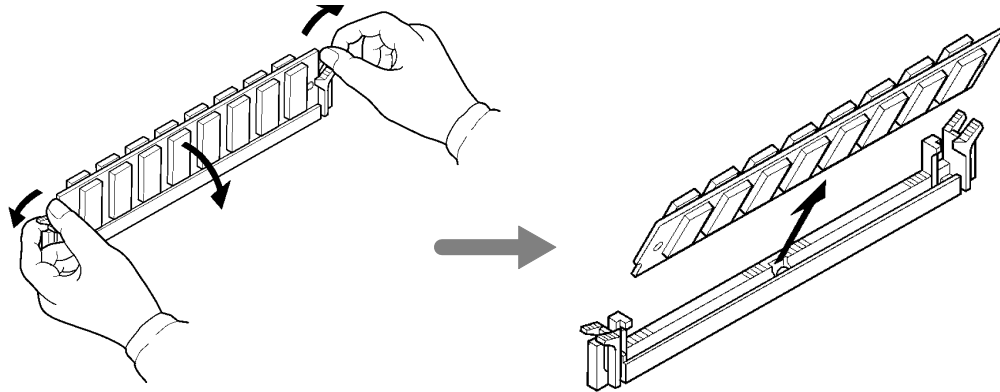

After SIMM has been installed in the printer, use the following procedure to check that installation has been performed properly.

Testing Extended Memory

1. Check that the power switch is off, plug the power cord into the printer, and turn the power on.
2. Wait for the printer's ON LINE/A4 indicator to light, then press and hold the **SHIFT** key followed by the **ON LINE/STATUS** key briefly.
3. If installation has been performed properly, a status page will be printed. Check the **Memory** in the upper right. Information on the SIMM installed in slot is shown here. There is no problem if total memory has increased. (The printer is shipped from the factory with 4096 KB [4 MB] of memory.)

Chapter 2

Operating the Page Printer

This chapter explains the printer's control panel and operating procedures.

Control panel	2-2
KIR Level	2-5
Ecoprint Mode.....	2-7
Manual Paper Feeding	2-8

Control Panel

The printer control panel consists of indicators and various keys.

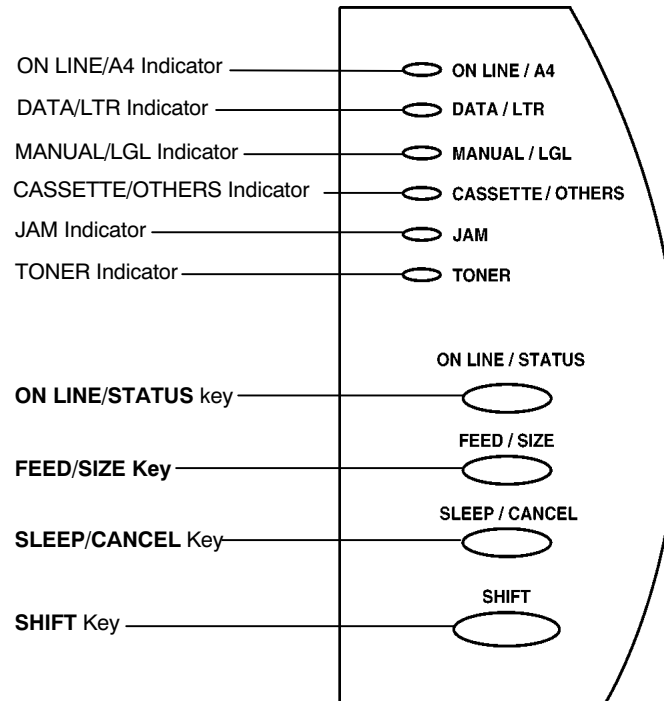

Indicators

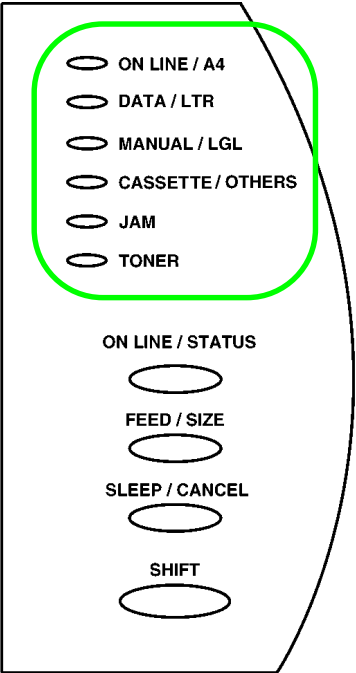

Refer to the table below for the names and meanings of indicators on the control panel.

Indicators on the Control Panel

Indicator	Status	Function
ON LINE/A4	Lit	The printer is on-line and ready to print received data. Also, this indicates that A4 size is selected for the current cassette when the FEED/SIZE key is pressed together with the SHIFT key.
	Off	The printer is off-line. The printer stores but not prints received data.
DATA/LTR	Flashing	The printer is receiving data from the host computer.
	Lit	The printer is processing the data for printing. Also, this indicates that letter size is selected for the current cassette when the FEED/SIZE key is pressed together with the SHIFT key.
MANUAL/LGL	Flashing	Indicates that there is no paper on the manual feed tray.
	Lit	Indicates that paper is fed from the manual feed tray. (If lit together with CASSETTE/OTHERS , it indicates that paper is fed from the PF-16 paper feeder, if installed.) Also, this indicates momentarily that legal size is selected when the SHIFT+FEED/SIZE key is pressed.
CASSETTE/OTHERS	Flashing	Indicates that there is no paper in the printer's cassette.
	Lit	Indicates that paper is fed from the printer's cassette (If lit together with MANUAL/LGL , it indicates that paper is fed from the PF-16 paper feeder, if installed.) Also, this indicates momentarily that A5* size is selected when the SHIFT+FEED/SIZE key is pressed.
JAM	Flashing	Indicates that the top cover is open.
	Lit	Indicates that paper is jammed.
TONER	Flashing	Indicates there is insufficient toner.
	Lit	Indicates that the printer is out of toner. Replace with a new toner container.

*: Factory default. The OTHERS size can be changed by PRESCRIBE FRPO T3 command (0=A5). For details, refer to PRESCRIBE 2e Programming manual in the Kyocera Digital Library CD-ROM.

Control Keys

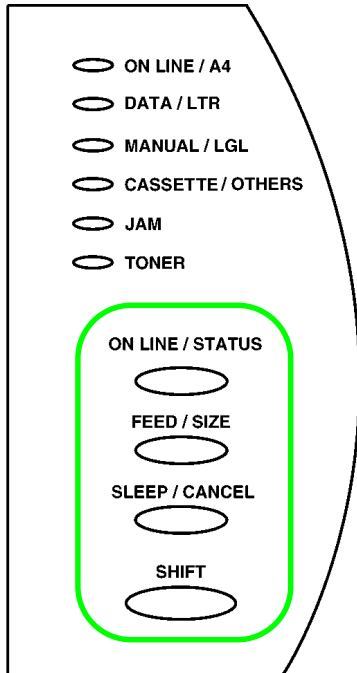

The functions of the control keys are given in the table below.

Key	Function	
	Primary	Secondary (when pressed with SHIFT key)
ON LINE/STATUS	Switches the printer online and offline.	Prints a page of status information.
FEED/SIZE	Selects the cassette feed, paper feeder, or manual feed.	Selects the paper size for the currently selected paper source.
SLEEP/CANCEL	Sets the sleep mode. Pressing a key on the control panel, opening and closing a cover, or sending data to the printer will cause the printer to begin warming up.	Abandons a printing job. (Press together with the SHIFT key at least one second.)
SHIFT	Invokes the secondary function of each of the above keys when pressed together.	

Note

Settings made from the control panel may be automatically switched to different settings by application software being used.

KIR Level

This printer incorporates the KIR (Kyocera Image Refinement) smoothing function. KIR provides high quality printing by providing a software-type improvement to the resolution.

You can set this at the printer setting menu of the application.

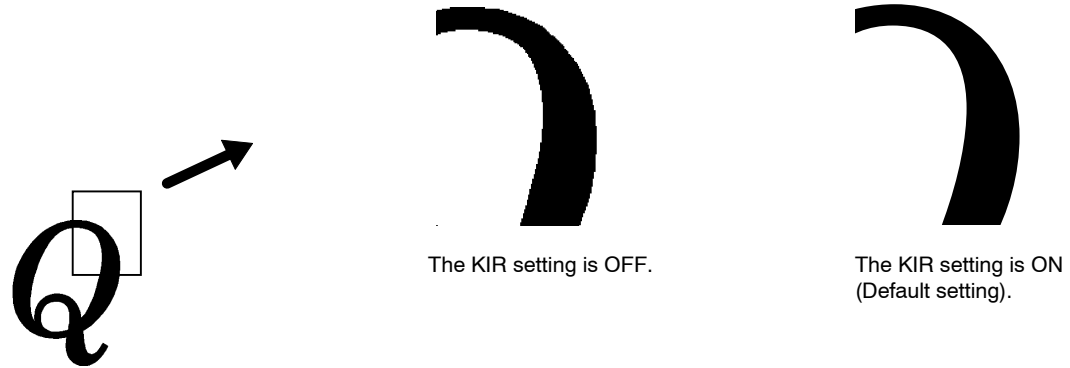

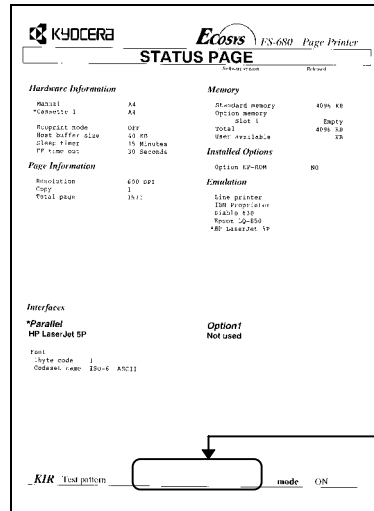

Note

You can look at the check line, the last line on a status page, to make the optimum KIR mode setting. Please refer to the table on the next page.

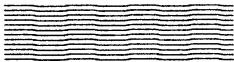

Status page

KIR Checking Lines

KIR Setting	Description
<p>Optimized stripes</p> 	The current KIR setting is optimal.
<p>Dark vertical stripes</p> 	Set the KIR mode to OFF.
<p>White vertical stripes</p> 	Set the KIR mode to ON.

Ecoprint mode

The Ecoprint enables you to reduce the amount of toner consumed on the page so as to save your printing costs. The factory-setting is off. You can set this at the printer setting menu of the application.

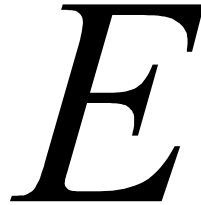
A large, bold, black serif capital letter 'E'.

Ecoprint is Off (default)

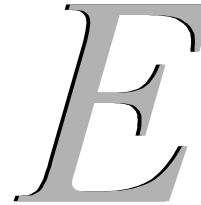
A large, light gray serif capital letter 'E'.

Ecoprint is On

Notes

The Ecoprint setting has no effect on the print speed.

Manual Paper Feeding

Manual paper feeding enables you to print on special paper without having to reload the paper feed cassette. **Appendix B** lists the usable types of paper.

Note

Since the printer does not sense the position of the manual feed paper guides, the printer assumes that all manually fed paper uses the legal size (8-1/2 x 14 inches).

1. Pull the paper cassette part-way open and lift the manual feed tray out of its compartment.

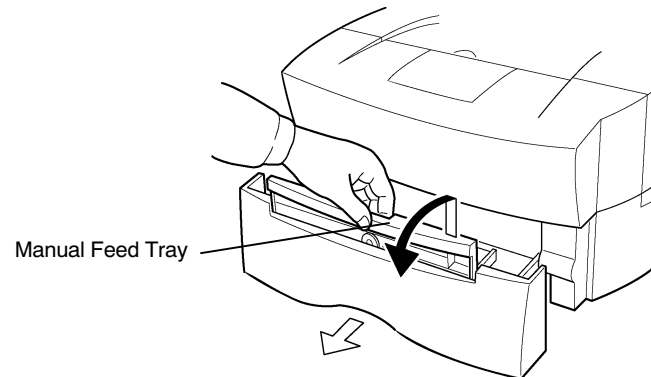

2. Fold the sub-tray outward, then adjust the paper guides to the size of the manually fed paper.

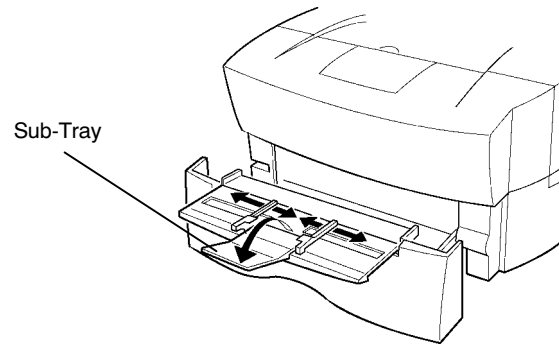

3. Making sure that the ON LINE/A4 indicator is lit, press the **FEED/SIZE** key so that the **MANUAL/LGL** indicator begins flashing.
4. Insert a sheet of paper as far as it will go. The ON LINE/A4 indicator also begins flashing.

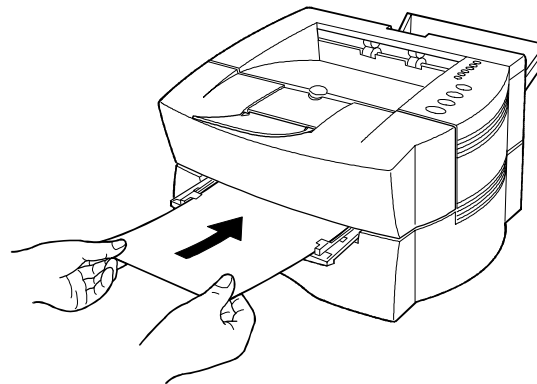

Note

Be sure to insert the sheet of paper as far as it will go.

5. Press the **ON LINE/STATUS** key. (The ON LINE/A4 and MANUAL/LGL indicators stop flashing and stay lit.)
6. Send printing commands and data from the computer. The DATA/LTR indicator begins flashing. When the data has processed (the DATA/LTR indicator stays lit), paper is fed from the manual feed tray.

To exit manual paper feed, press the **FEED/SIZE** key to light the CASSETTE/OTHERS indicator.

Feeding Envelopes

Envelopes should be fed in the face up, right edge first.

Note

To avoid trouble, we recommend that envelopes are delivered face-up using the face-up tray.

Not all envelopes print well. See **Appendix B** for details on suitable types of envelopes.

Overhead Projection (OHP) Film

To avoid feed problems, OHP film must be fed manually in the manner described above.

Requirements regarding OHP film are also given in **Appendix B**.

Note

OHP film must be delivered face-up.

Auto Manual Feeding

Feeding one sheet of paper at a time from the manual tray is possible even if the current paper feed source is the cassette or the optional paper feeder (PF-16). This feature is useful when you want the first page of a letter printed on a letterhead paper and remaining pages on the normal paper from the paper cassette.

1. Making sure that the ON LINE/A4 indicator is lit, place a sheet of letterhead paper on the manual feed tray in the same manner as when printing normally from the manual tray. (The ON LINE/A4 and MANUAL/LGL indicators begin flashing.)
2. Send data to the printer.
3. Press the **ON LINE/STATUS** key. (The ON LINE/A4 and MANUAL/LGL indicators stop flashing and stay lit.)
4. The printer automatically prints the first page on the letterhead paper on the manual tray, and subsequent pages on the remaining sheets in the paper cassette.

Returning the Manual Feed Tray

Return the manual feed tray to its original position by reversing steps 1 to 2 (pages 2-8 and 2-9).

Note

Be careful not to push the tray back into the printer with the sub-tray folded out horizontally as shown in the figure.

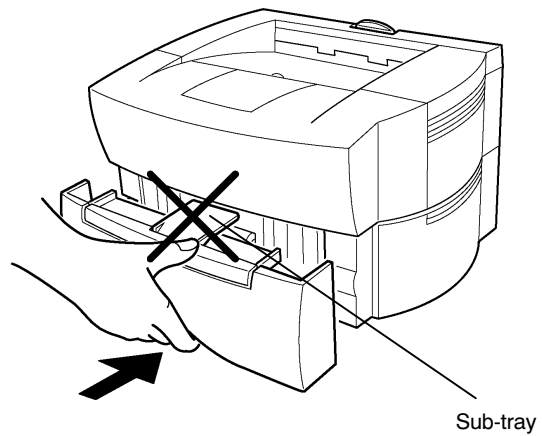

Chapter 3

Fonts

This chapter describes the types of fonts you can use with the printer, including the printer's resident and KPD L fonts (option), and symbol sets.

Fonts	3-2
List of Fonts	3-3

Fonts

A font is a set of characters of a particular design. The design is referred to as a typeface. Several characteristics identify a font. These include the font type (bit map or scalable), symbol set, spacing, pitch, height, style, stroke weight, and typeface family.

The printer provides two types of fonts: bitmap fonts and scalable (outline) fonts. Also, fonts may be downloaded to the printer's memory. These fonts are referred to as downloadable or soft fonts. The printer accepts as many downloadable fonts as its user available memory permits.

Scalable fonts provide the outline of the characters. This outline is scaled according to the scaling information from the computer and filled in for printing. Depending on the capabilities of the software you use, the scalable fonts can be scaled from 0.25 point to 999.75 points in quarter point increments.

List of Fonts

This section contains a full list of the printer's resident scalable fonts.

Bitmap Fonts

The printer has 80 bitmap fonts. Note that all bitmap fonts include the letters BM in the typeface name.

Scalable Fonts

The printer has 45 resident scalable fonts. These fonts include the letters SWC or SWM in the typeface name and are equivalent to HP LaserJet 5P fonts.

Option Fonts

You can install any of the KPDL option fonts.

KPDL fonts

The PostScript Type 1 compatible KPDL fonts are available when the printer is installed with the KPDL (Kyocera Page Description Language: Kyocera's version of PostScript) KPDL upgrade kit (PK-series).

Resident Scalable Fonts (2)

This is a sample of Ribbon131-Roman-SWC font.

This is a sample of Swiss721-BoldObliqueSWM font.

This is a sample of Swiss721-BoldSWM font.

This is a sample of Swiss721-ObliqueSWM font.

This is a sample of Swiss721-SWM font.

This is a sample of Swiss742SWC-Bold font.

This is a sample of Swiss742SWC-BoldCondensed font.

This is a sample of Swiss742SWC-BoldCondensedItalic font.

This is a sample of Swiss742SWC-BoldItalic font.

This is a sample of Swiss742SWC-Italic font.

This is a sample of Swiss742SWC-ItalicCondensed font.

This is a sample of Swiss742SWC-Roman font.

This is a sample of Swiss742SWC-RomanCondensed font.

Τηισ ισ α σαμπλε οφ Συμβολ-Σετ-ΣΩΜ φοντ.

(This is a sample of Symbol-Set-SWM font.)

This is a sample of ZapfHumanist601SWC-Bold font.

This is a sample of ZapfHumanist601SWC-BoldItalic font.

This is a sample of ZapfHumanist601SWC-Demi font.

This is a sample of ZapfHumanist601SWC-Demitalic font.

KPDL Fonts (1)

This is a sample of Century-Schoolbook-SWA font.

This is a sample of Century-Schoolbook-ItalicSWA font.

This is a sample of Century-Schoolbook-BoldSWA font.

This is a sample of Century-Schoolbook-BoldItSWA font.

This is a sample of Courier-SWA font.

This is a sample of Courier-ItalicSWA font.

This is a sample of Courier-BoldSWA font.

This is a sample of Courier-BoldItalicSWA font.

This is a sample of Dutch801-RomanSWA font.

This is a sample of Dutch801-ItalicSWA font.

This is a sample of Dutch801-BoldSWA font.

This is a sample of Dutch801-BoldItalicSWA font.

This is a sample of ITC-Avant-Garde-BookSWA font.

This is a sample of ITC-Avant-Garde-BookObliqueSWA font.

This is a sample of ITC-Avant-Garde-DemiSWA font.

This is a sample of ITC-Avant-Garde-DemiObliqueSWA font.

This is a sample of ITC-Bookman-LightSWA font.

This is a sample of ITC-Bookman-LightItalicsSWA font.

This is a sample of ITC-Bookman-DemiSWA font.

This is a sample of ITC-Bookman-DemiItalicSWA font.

This is a sample of ITC-Garamond-LightSWA font.

This is a sample of ITC-Garamond-LightItalicSWA font.

This is a sample of ITC-Garamond-BoldSWA font.

This is a sample of ITC-Garamond-BoldItalicSWA font.

Chapter 4 Maintenance

This chapter explains how to maintenance the printer. This only covers replacing the toner container and cleaning parts such as registration roller and laser scanner glass.

Toner Container Replacement.....	4-2
Cleaning.....	4-9

Toner Container Replacement

When the printer runs low on toner, TONER indicator flashes on the control panel. Be sure to promptly replace with a new toner kit and clean the inside of the printer when this initial message appears.

If the printer stops printing while TONER indicator is lighting, replace with a new toner kit so the printer can continue printing.

Toner Container Replacement Interval

Assuming an average toner coverage of 5% with Ecoprint mode turned off, the toner container will need replacing approximately once every 3,600 printed pages (3,000 pages with TK-16).

Toner Kit to be Used

Name: TK-16/TK-16H (The toner kit included with the printer is the TK-16H.)
Description: Toner Container
Cleaning Cloth
Cap For Old Toner Container
Plastic Waste Bag (The toner kit supplied with the printer does not contain a plastic waste bag.)
Instruction Manual

Notes

- Do not use the toner inside the old toner container.
- Be sure to distance items such as floppy disks during toner container replacement.
- Be sure to clean the inside of the printer along with replacing the toner container. For details, see “**Cleaning**” on page 4-9.
- Use of original Kyocera toner kits is highly recommended to prevent printer trouble and ensure the long life of the printer.

Replenishing Toner

1. Open the top cover.

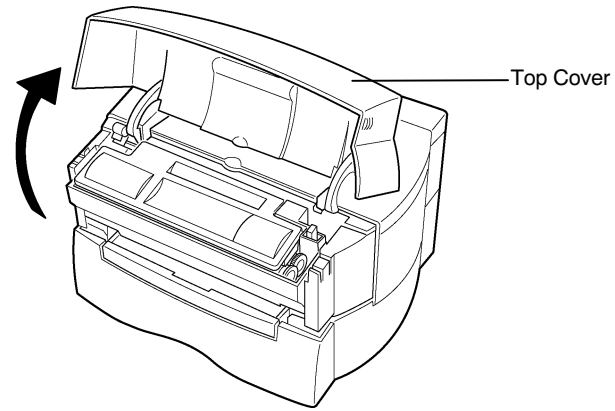

2. Slide the toner container release lever to the right to release the old toner container from the printer. After removing it, take care not to tilt the toner container.

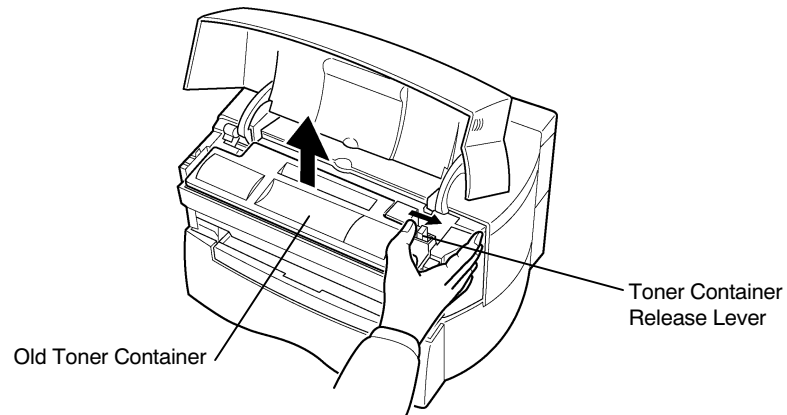

3. Use the cap provided in this toner kit to cover the removed toner container as shown in the diagram below. This is to prevent the waste toner from spilling.

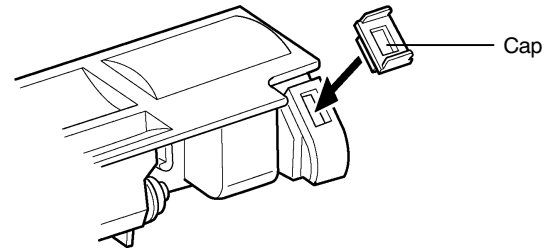

4. Dispose of the old toner container in the plastic waste bag supplied in the new toner kit so that toner does not scatter.

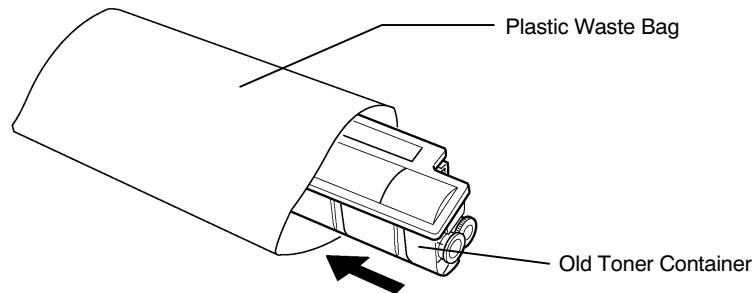

Note

Although the toner container is made from non-harmful, flammable material, be sure to dispose of this waste according to local laws and regulations.

5. Take the new toner container from the toner kit. Shake the toner container with the protective seal (orange-colored) facing up as shown in the figure five times or more to thoroughly mix the toner inside.

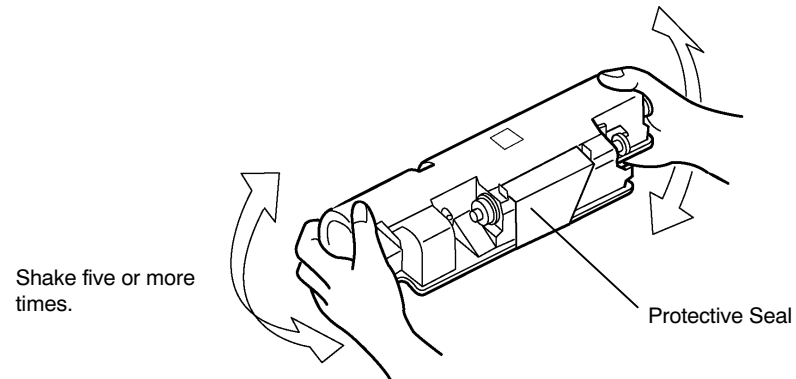

6. Carefully remove the protective seal.

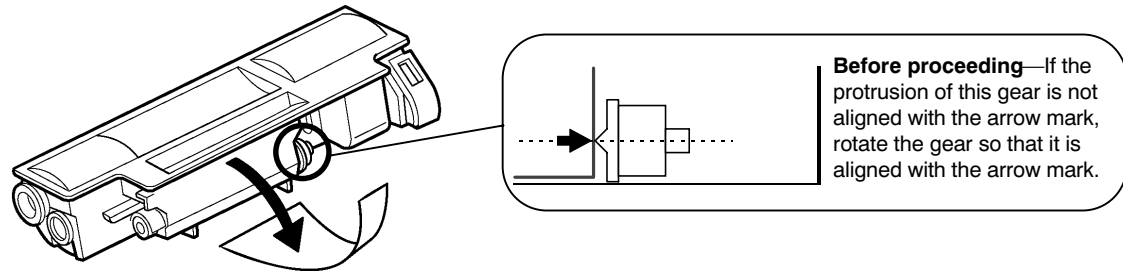

7. Align the ends of the toner container with the grooves to the left and right inside the printer and install.

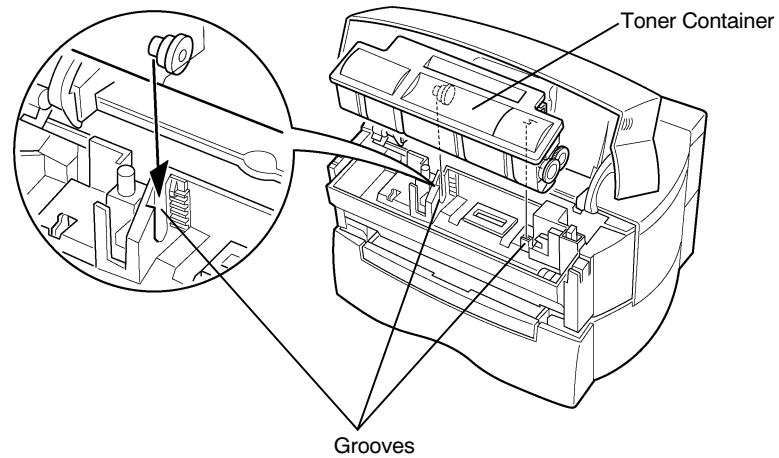

8. Check that the toner container is installed in the correct position, and push forcefully on the top of the toner container "PUSH HERE."

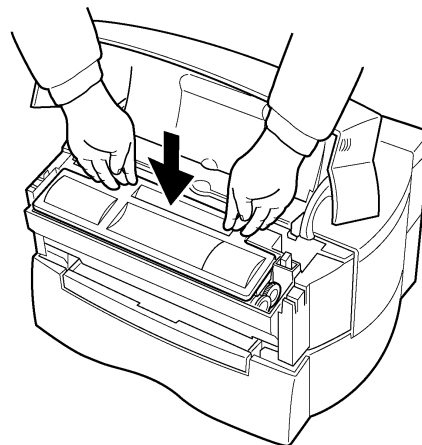

Note

Make sure that the toner container is properly locked into the printer.

9. Close the top cover.

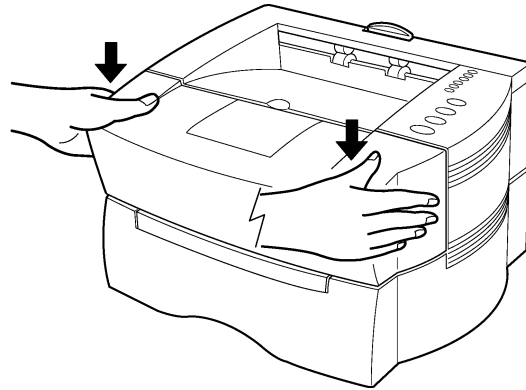

Cleaning

To avoid print quality problems, the interior of the printer must be cleaned with every toner container replacement.

Note

Cleaning should be done from time to time to avoid print quality problems.

Printer Interior

Note

Before cleaning the interior of the printer, switch off the printer power.

To avoid print quality problems due to paper dust and debris, clean the interior of the printer in the following manner.

1. Lift the process unit out of the printer. **The drum in the process unit is sensitive to light. Do not expose the drum even to normal office lighting (500lux) for more than five minutes.**

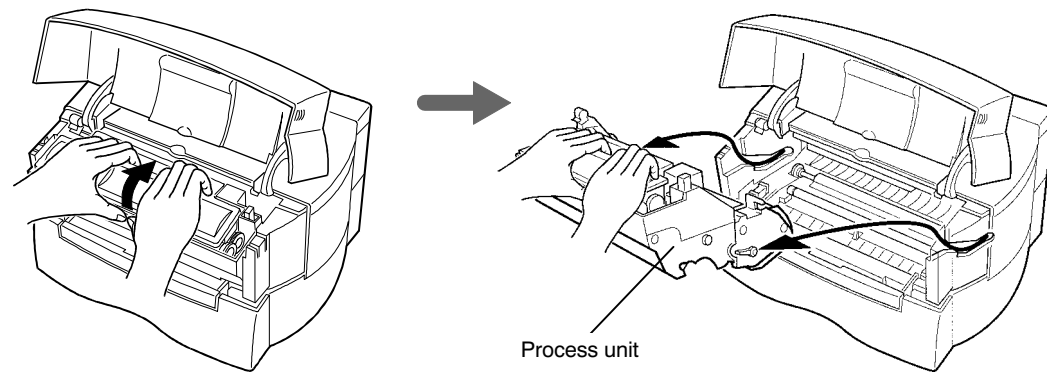

2. Use the cleaning cloth provided together with this kit to clean dust and dirt away from the registration roller and laser scanner cover glass.

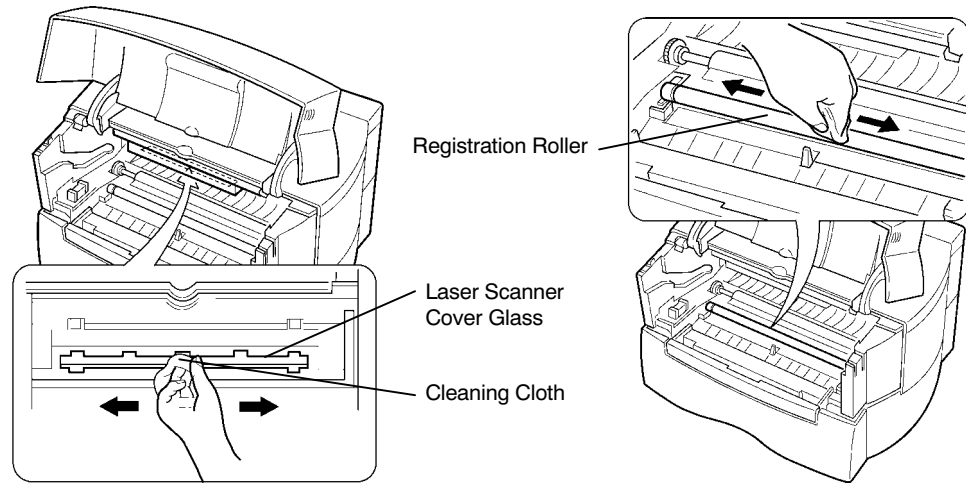

Note

While cleaning, be careful to avoid touching the transfer roller (the black roller) and laser scanner cover glass.

3. After cleaning is done, install the process unit in the printer. In doing so, carefully align the guides at the both ends of the process unit properly with the slots in the printer.

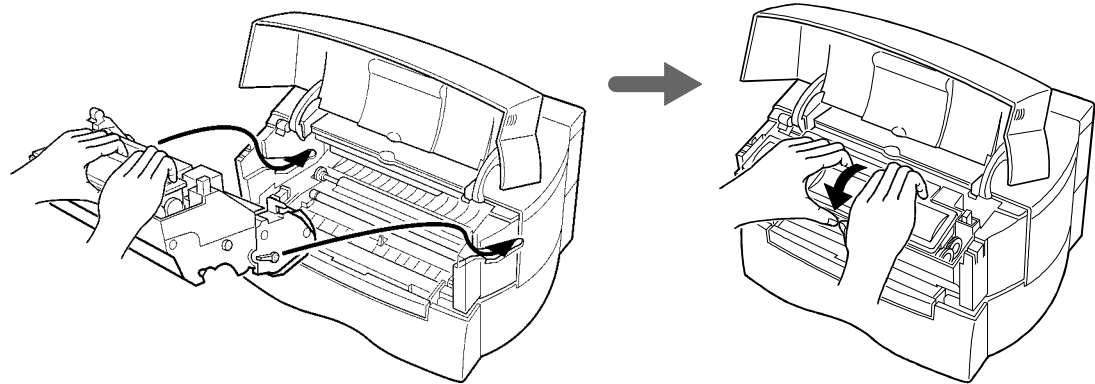

4. Close the printer's top cover by pressing down on the front left and right corners of the top cover.

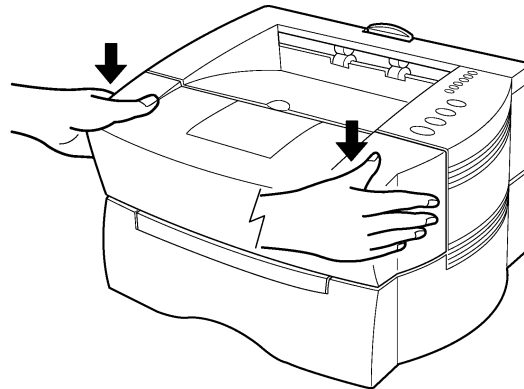

Chapter 5

Troubleshooting

This chapter explains how to handle printer problems which may occur. If a problem cannot be corrected, please contact your Kyocera dealer.

- General Guide 5-2
- Print Quality Problems 5-4
- Indicators 5-8
- Correcting a Paper Jam..... 5-12

General Guide

There are quite a few printer problems which may be corrected by the user. This section explains how to correct these problems.

If some kind of printer problem should occur, check the following before concluding the printer is broken.

Symptom	Check Items		Corrective Action
The printer will not print.	Check the ON LINE/A4 indicator.	Off	Press the ON LINE/STATUS key. If the indicator remains off and the printer still will not print even after pressing the ON LINE/STATUS key, the problem may be power-related. Look through the items below and check anything that seems appropriate.
		Lit	See the appropriate item below.
	Check the print quality of a status page if one can be printed.	No problem	There may be a problem in the connection with the computer. Look through the items below and check anything that seems appropriate.
		There is a problem	See the section on Print Quality Problems (See page 5-4).
Paper is jammed.			See the section on Correcting a Paper Jam .

(Continued on next page)

Symptom	Check Items	Corrective Action
Nothing lights on the control panel even when power is turned on and the fan makes no noise.	Check that the power cord is properly plugged into the power outlet.	Turn off the printer's power, plug in the power cord securely, and try turning on the printer's power again.
	Check that the power switch is really in the on position.	
The printer prints a status page, but data from the computer is not being printed normally.	Check the interface cable.	Connect both ends of the interface cable securely. Try replacing the printer cable. For details on the parallel interface of this printer, see Appendix C .
	Check program files and application software.	Try printing another file or using another print command. If the problem occurs only with a specific file or application, check the printer settings for that application.

If you still cannot correct a printer problem even after checking the above, please contact your Kyocera dealer.

Print Quality Problems

There are many possible causes of the print quality problems, such as blank output, shown in the table below. The troubleshooting procedure for each type of problem is given below. If the checks explained in this section do not solve the problem, please contact your Kyocera dealer.

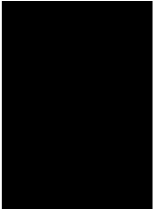

Printed Results	Corrective Action
<p>All-black printout</p> 	<p>Please contact your Kyocera dealer.</p>

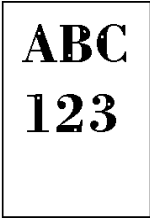
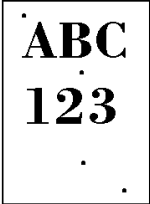
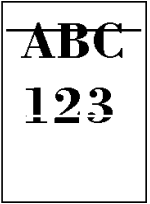
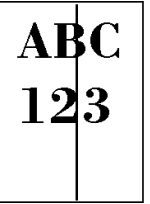
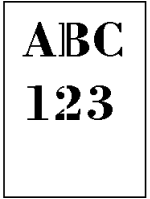
(Continued on next page)

Printed Results	Corrective Action
<p data-bbox="600 209 1039 234">Dropouts, horizontal streaks, stray dots</p> <div data-bbox="622 268 770 484">A rectangular box containing the text 'ABC' on the top line and '123' on the bottom line. There are several small black dots scattered around the text, representing stray dots or dropouts.</div> <div data-bbox="819 268 967 470">A rectangular box containing the text 'ABC' on the top line and '123' on the bottom line. There are horizontal streaks across the text, representing print quality issues.</div> <div data-bbox="622 518 770 720">A rectangular box containing the text 'ABC' on the top line and '123' on the bottom line. There are horizontal streaks across the text, similar to the previous example.</div>	<p data-bbox="1126 209 1537 234">Clean the laser scanner cover glass.</p> <p data-bbox="1126 255 1779 340">Open the printer's top cover. Clean the laser scanner cover glass using the wiper cloth. (See Chapter 4.)</p>
<p data-bbox="600 760 937 784">Black or white vertical streaks</p> <div data-bbox="622 799 770 1001">A rectangular box containing the text 'ABC' on the top line and '123' on the bottom line. A vertical black line runs through the center of the text, representing a vertical streak.</div> <div data-bbox="819 799 967 996">A rectangular box containing the text 'ABC' on the top line and '123' on the bottom line. A vertical white line runs through the center of the text, representing a vertical streak.</div>	<p data-bbox="1126 760 1402 784">Check the control panel.</p> <p data-bbox="1126 805 1779 860">If the toner indicator is flashing, install a new toner kit. Clean the printer after replacement. (See Chapter 4.)</p> <hr/> <p data-bbox="1126 897 1537 921">Clean the laser scanner cover glass.</p> <p data-bbox="1126 942 1779 997">Open the printer's top cover. Clean the laser scanner cover glass using the wiper cloth. (See Chapter 4.)</p>

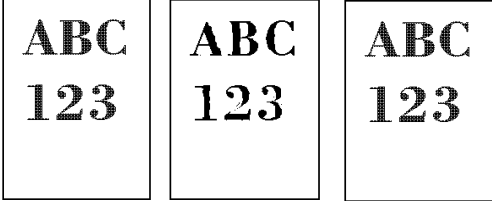
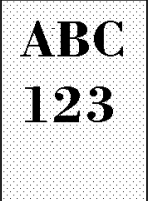
(Continued on next page)

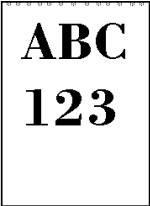
Printed Results	Corrective Action
<p>The image is smeared.</p> 	<p>Clean the laser scanner cover glass.</p> <p>Open the printer's top cover. Clean the laser scanner cover glass using the wiper cloth. (See Chapter 4.)</p>
<p>Faint or blurred printing</p> 	<p>Check the Ecoprint setting. (See Chapter 2.)</p> <p>If the toner indicator is flashing, install a new toner kit. (See Chapter 4.)</p> <p>Clean the laser scanner cover glass.</p> <p>Open the printer's top cover. Clean the laser scanner cover glass using the wiper cloth. (See Chapter 4.)</p> <p>Try setting the thin paper mode.</p> <p>Send the following PRESCRIBE 2e command from the computer to set the thin paper mode.</p> <pre>!R! FRPO T9, 2; EXIT;>PRN</pre> <p>This may improve the printing quality. (To return to the original setting, send the command again with "T9, 2;" changed to "T9, 0;".)</p>
<p>Grey background.</p> 	<p>Check the control panel.</p> <p>If the toner indicator is flashing, install a new toner kit. (See Chapter 4.)</p> <p>Check the process unit.</p> <p>Open the printer's top cover and check that the process unit is properly installed.</p>

Printed Results	Corrective Action
<p data-bbox="610 211 1054 237">Dirt on the top edge or back of the paper</p> <div data-bbox="620 266 768 470">  </div> <div data-bbox="832 266 977 470">  </div>	<p data-bbox="1137 211 1408 237">Check the transfer roller.</p> <p data-bbox="1137 257 1789 337">Lift the process unit out of the printer and check whether the transfer roller is dirty. If so, print several pages to eliminate the dirt.</p> <p data-bbox="1137 362 1447 388">Check the registration roller.</p> <p data-bbox="1137 408 1802 488">Lift the process unit out of the printer and check whether the registration roller is soiled with toner. If so, wipe it clean using the supplied cleaning cloth.</p>
<p data-bbox="610 540 900 566">Characters out of position.</p> <div data-bbox="624 591 768 795">  </div>	<p data-bbox="1137 540 1421 566">Check the file or program.</p> <p data-bbox="1137 587 1802 696">See if the problem is caused by an error with PRESCRIBE 2e commands. If the problem occurs only with a specific file or program, the most likely cause is an error in a parameter to a command or command syntax.</p>

Indicators

This section explains the indicators on the control panel and the appropriate corrective action to take in each case.















Whether the indicator is lit, flashing or off is indicated as shown in the following diagram. Although there is fast flashing and slow flashing, they are not distinguished diagrammatically.















Maintenance Indications

Indicators	Corrective Action
<ul style="list-style-type: none"> ● ON LINE / A4 ● DATA / LTR ● MANUAL / LGL ○ CASSETTE / OTHERS ◉ JAM ● TONER 	<p>The top cover is open.</p> <p>Close it tightly. (In this example, the printer's cassette is selected.)</p>
<ul style="list-style-type: none"> ○ ON LINE / A4 ● DATA / LTR ● MANUAL / LGL ◉ CASSETTE / OTHERS ● JAM ● TONER 	<p>The paper source is out of paper.</p> <p>Add paper to the paper cassette or manual feed tray. (In this example, there is no paper in the printer's cassette. If there was no paper in the optional cassette, both the MANUAL/LGL and CASSETTE/OTHERS indicators would flash. If there were no paper in the manual feed tray the MANUAL/LGL indicator would flash.)</p> <hr/> <p>The cassette is not closed securely.</p> <p>Close it tightly.</p>













(Continued on next page)

Indicators	Corrective Action
 ON LINE / A4  DATA / LTR  MANUAL / LGL  CASSETTE / OTHERS  JAM  TONER	<p>Add a sheet of paper to the manual feed tray, and press the ON LINE/STATUS key. Printing will start. (The DATA/LTR indicator also flashes if data is being sent.)</p>
 ON LINE / A4  DATA / LTR  MANUAL / LGL  CASSETTE / OTHERS  JAM  TONER	<p>Open the printer and correct the paper jam. See page 5-12.</p> <p>The indicator on the front panel also flashes the location of the paper jam. (In this example, a paper jam occurred in the printer's cassette. If the jam had occurred in the optional cassette, both the MANUAL/LGL and CASSETTE/OTHERS indicators would flash. If the jam had occurred in the manual feed tray, the MANUAL/LGL indicator would flash.)</p>
 TONER	<p>There is not enough toner inside the toner container.</p> <p>Be sure to promptly replace with a new toner as the printer will stop printing before long. Clean the printer after replacement. (SeeChapter 4.)</p>
 TONER	<p>There is no more toner in the toner container.</p> <p>The printer has stopped because there is no more toner. Replace with a new toner kit. After replacing, be sure to clean the printer. (SeeChapter 4.)</p>

(Continued on next page)

Indicators	Corrective Action
 ON LINE / A4  DATA / LTR  MANUAL / LGL  CASSETTE / OTHERS  JAM  TONER	<p>A failure requiring the attention of service personnel has occurred.</p> <p>A failure requiring the attention of service personnel has occurred and the printer has stopped.</p>
 ON LINE / A4  DATA / LTR  MANUAL / LGL  CASSETTE / OTHERS  JAM  TONER	

Error Indications

Indicators	Corrective Action
 ON LINE / A4  DATA / LTR  MANUAL / LGL  CASSETTE / OTHERS  JAM  TONER	<p>Current print processing cannot continue due to insufficient memory.</p> <p>Check available user memory by printing a status page, and either remove unnecessary download fonts and/or macros or expand the printer's memory. Press the ON LINE/STATUS key to print data as far as it was stored. You can abandon printing by the SHIFT key and SLEEP/CANCEL key.</p>
 ON LINE / A4  DATA / LTR  MANUAL / LGL  CASSETTE / OTHERS  JAM  TONER	<p>Current print processing cannot continue due to a too complex page.</p> <p>The data transferred to the printer was too complex to print on a page. Press the ON LINE/STATUS key to print data as far as it was stored. You can abandon printing by the SHIFT key and SLEEP/CANCEL key.</p> <p>Note: Send the following command to the printer after this error has occurred:</p> <pre>!R! FRPO R5, 1; EXIT;</pre> <p>to release the page protect mode.</p>

Correcting a Paper Jam

This section describes how to remove paper when it jams in the printer. The printer will stop whenever paper jams in the printer or paper is not fed from a cassette. The printer will go offline and Jam indicator will light in the control panel.

When a jam occurs, check the points indicated in the following and clear the jam as indicated.

Jam at the Face-down and Face-up Trays

If paper is fed part way out into the tray, pull the paper out the rest of the way by hand. Open and close the printer's top cover to clear the error.

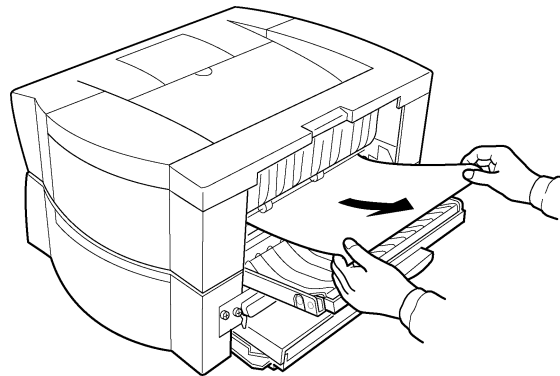

Jam at the Paper Cassette and the (Optional) Paper Feeder's Cassette

Pull out the paper cassette and remove any partially fed paper, then re-close the paper cassette. Open and close the printer's top cover to clear the error. Follow the same steps for clearing the jammed paper at the option paper feeder's cassette.

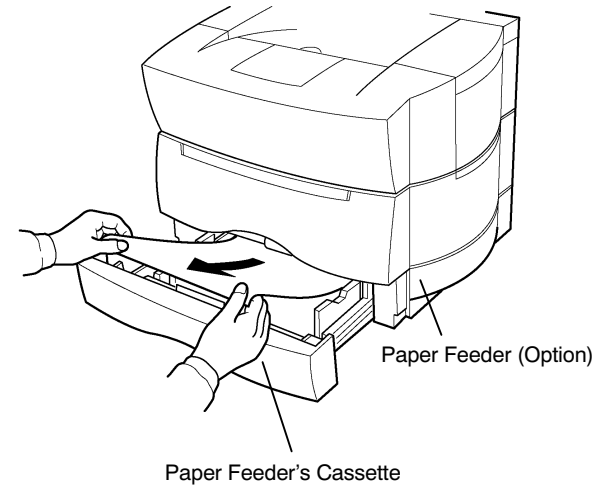
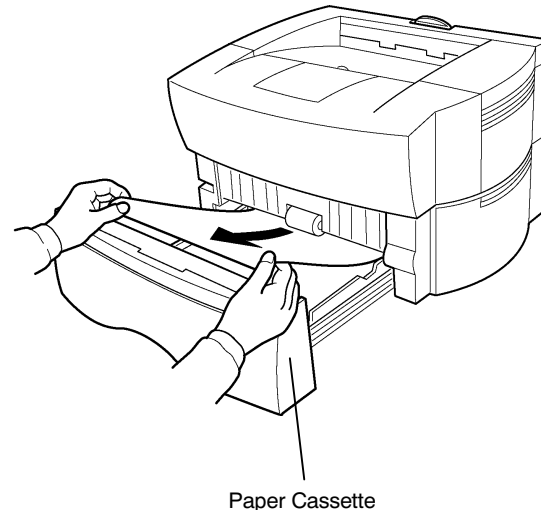

Jam Inside the Printer

Open the printer's top cover and remove the process unit. Remove any jammed paper, then replace the process unit and close the top cover. For removal/installation method of the process unit, refer to **Cleaning** (page 4-9).

Note

If the jammed paper appears to be pinched by rollers, pull it along the normal paper running direction.

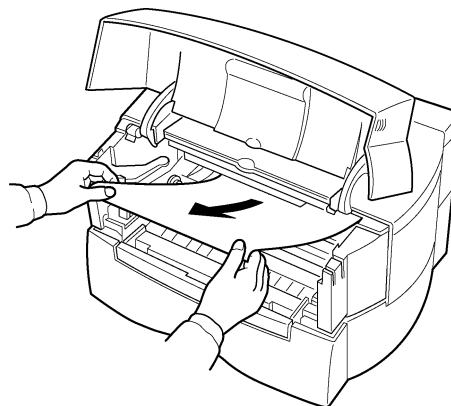

Notes after removing the paper jam

Once the jammed paper is removed, opening and closing the printer's top cover clears the jam error. The printer then automatically warms up and resumes printing. Depending on where the jam occurred, the printer may or may not reprint the jammed page.

If paper jams occur frequently, try using a different type of paper, replace with paper from another ream, turn the stack of paper over, or turn the paper the other way around. Read the information in **Appendix B**. Also, look for tiny pieces of paper that may have been torn apart and overlooked when the jammed paper was removed.

If you cannot solve the problem by changing the paper, there may be a problem with the printer. Call a service person.

Note

When pulling the paper, pull it gently so as not to tear it. Torn pieces of paper are difficult to remove and may be easily overlooked, deterring the jam recovery.

Appendix A Printer Specifications

Printer Specifications

Item	Description
Printing method	Electrophotography
Printing speed (when printing multiple copies of the same page)	8 pages/minute
Resolution	600 dots/inch (vertical and horizontal) with KIR (Kyocera Image Refinement).
First print (A4, 23°C)	Sleep mode off - 25 seconds or less Sleep mode on - 55 seconds or less
Warm-up time (23°C)	30 seconds or less
Controller	PowerPC 401GF (50 MHz)
Main memory	4 MB, expandable up to 36 MB, with one SIMM slot
Supported operating systems	Windows 3.1, Windows 95, Windows 98, Windows NT
Supported protocols	IPX/SPX, TCP/IP, DLC
Interfaces	High-speed bidirectional parallel interface × 1 Optional interface slot × 1
Self test	Performed at power-up
Maximum duty cycle	8,000 pages/month (dry A4 PPC standard paper)
Drum	Organic photoconductor
Developer	Dual-component dry developer
Main charger	Roller charging type
Transferring	Roller charging type
Separation	Curvature separation
Drum cleaning	Blade cleaner
Fuser	Heat roller and pressure roller
Toner saving	Ecoprint mode

Item	Description
Paper	Plain paper (See Appendix B.)
Paper sizes	Cassette: Letter size, A4 to A5 universal cassette Manual feed tray: 80 mm x 148 mm to 215.9 mm x 355.6 mm
Paper capacity	Cassette: 150 sheets each (80 g/m ² , [0.11-mm thickness]) Manual feed tray: 1 sheet (80 g/m ² , [0.11-mm thickness])
Capacity of output trays	Face-down tray—150 sheets (80 g/m ² , [0.11-mm thickness]) Face-up tray—10 sheets (80 g/m ² , [0.11-mm thickness]) (Only one sheet of special paper may be placed in the tray.)
Ambient conditions	Temperature: 10°C to 32.5°C (50°F to 90.5°F) Humidity: 20% to 80% RH Optimum conditions: 23°C (68°F), 65% RH Altitude: Max. 2000m (6500 feet)
Power supply	120 V, 60 Hz, max. 4.3 A (U.S.A.) 230 V, 50/60 Hz, max. 2.1 A (European countries, Australia) Max. allowable voltage fluctuation: ±10% Max. allowable frequency fluctuation: ±2%
Power consumption	Max.: 485 W/230V, 510W/120V During normal operations: 200 W During standby: 62 W During sleep mode: 10 W
Noise	During printing: Max. 46 dB (A) During idling: Max. 25 dB (A) During sleeping: Unmeasurably low
External dimensions	363 mm (14.3") wide × 222 mm (8.7") high × 360 mm (14.2") deep (Excl. the paper tray)
Weight	8.5 kg (18.7 lbs.), main unit only

Appendix B

Paper Selection

General Guidelines

Although the page printer is designed for printing on standard dry PPC photocopier copy paper (standard paper), it can print on various types of paper that conforms to the specifications given in this chapter.

Select paper carefully as use of paper inappropriate for the printer may result in paper jams or wrinkling of output paper. Low-quality paper may reduce printing quality, not only wasting paper but possibly leading to damage to the printer. It is possible to achieve efficient printing with few problems and minimize the risk of printer damage or wear by following the precautions listed below.

Usable Paper

Be sure to use copy paper (standard paper) used in standard dry PPC photocopiers.

Note

Some recycled paper does not meet the necessary specifications for use in this printer due to conditions such as stored water and pulp content. Before purchasing recycled paper, test a sample on the printer and check that printing quality is satisfactory. Be sure to select a brand of recycled paper which offers good printing quality and does not contain excessive levels of paper dust.

There are differences in grade between each paper manufacturer, and these differences can affect printer operations. Satisfactory printing results cannot be obtained through the use of poor-quality paper. Even inexpensive paper may turn out to be uneconomical from a results standpoint if its quality is inappropriate for the printer.

Paper Specifications

The following table summarizes the basic paper specifications. Details are given on the following pages.

Paper Specifications

Weight	60 to 90 g/m ² (16 to 24 lbs./ream)
Thickness	0.086 to 0.110 mm (3.4 to 4.3 mils)
Dimensional accuracy	±0.7 mm (±0.0276 inches)
Squareness of corners	90° ±0.2°
Moisture content	4% to 6%
Direction of grain	Long grain (Paper feed direction)
Pulp content	80% or more
Smoothness	20 seconds or more

Note

Consult with your Kyocera dealer before purchasing any specially treated paper or special application paper.

Kyocera bears absolutely no responsibility for accidents resulting from the use of inappropriate paper which does not meet the specifications listed above. For paper, contact the licensed dealer of Kyocera from which you purchased the printer.

Selecting the Right Paper

The following sections explain the basic things to look for when selecting paper. Keep these things in mind when selecting paper.

Condition of the Paper

Avoid using paper that is folded at the corners, curled, dirty, stained, has fuzzy fibers, rough surface or is easily torn.

Use of paper in these conditions can lead to illegible printing, misfeeding, and paper jams, and can shorten the life of the printer. Select paper which has as smooth and even a surface as possible. Note that use of paper with a surface coating or other surface treatment may damage the drum or fuser unit.

Composition

Do not use paper that has been coated or surface-treated and contains plastic or carbon. The heat of fusing can cause such paper to give off harmful fumes, and may damage the drum.

Bond paper should contain at least 80% pulp. Not more than 20% of the total paper content should consist of cotton or other fibers.

Paper Size

Cassettes and the manual feed tray can handle the paper sizes listed in the following table. The printer automatically detects the paper size loaded in a cassette.

Paper Sizes for Paper Feeding

Paper	Size
ISO A4	210 x 297 mm
ISO A5	148 x 210 mm
JIS B5	182 x 257 mm
Letter	8.5 x 11 inches
Legal	8.5 x 14 inches

Other sizes of paper can be fed from manual feed tray. The minimum size of fed paper is 80 x 148 mm (3.1 x 5.8 inches). The maximum size is 216 x 356 mm (8.5 x 14 inches). (Printing position adjustment is required.)

Smoothness

Although it is important to use paper with a smooth and even surface, do not use paper which has been coated. Paper that is too smooth, can cause multiple feeding and paper jams.

Basis Weight

Basis weight is the weight of one square meter sheet of paper. Paper that is too light or too heavy can cause misfeeding, jams, and premature wear of the printer. Uneven paper weight can cause multiple feeds, print defects, poor toner fusing, blur-ring, and other print quality problems. The proper weight is 60 to 90 g/m² (16 to 24 lbs/ream). Paper weights of up to 163 g/m² can be handled when feeding from the manual feed tray. However, this should be tested before use.

Thickness

The paper used with the printer should be neither extremely thick nor extremely thin. If you are having problems with multiple feeds and paper jams, the paper may be too thin. The paper may also be too thick if you are having problems with paper jams. The proper thickness is 0.086 to 0.110 mm (3.4 to 4.3 mils).

Moisture Content

Moisture content is defined as the percent ratio of moisture to the dry mass of the paper. Moisture can affect feedability, electrostatic properties, and toner fusing characteristics.

The moisture content of the paper varies with the relative humidity in the room. When the relative humidity is high and the paper absorbs moisture, the paper edges expand, becoming wavy in appearance. When the relative humidity is low and the paper loses moisture, the edges shrink and tighten, and print contrast may suffer.

Wavy or tight edges can cause misfeeding and alignment anomalies. The moisture content of the paper should be 4% to 6%.

To ensure the proper moisture content it is important to store the paper in a controlled environment. Some tips on moisture control are:

- **Store paper in a dry, well-ventilated location.**
- **Keep the paper flat and in its wrapping as long as possible. Rewrap paper that is not in use.**
- **Store paper in its original carton. Place a pallet etc. under the carton to separate it from the floor. Keep paper away from boarding or concrete floors during the rainy season.**
- **Avoid leaving paper where it is exposed to heat, sunlight, or damp.**

Paper Grain

When paper is manufactured, it is cut into sheets with the grain running parallel to the length (long grain) or parallel to the width (short grain).

Use paper whose grain runs in the same direction as it will be fed through the printer. Some paper manufacturers indicate the direction of the grain on their packaging. Please ask the retailer if you cannot tell by yourself.

Other Paper Properties

Stiffness

Paper that is too limp or too stiff may fold or bend inside the printer, resulting in a paper jam.

Curl

Most paper has a natural tendency to curl in one direction or the other if it is stored unwrapped. Paper will curl slightly upward when it passes through the fuser unit. Load the paper with its natural curl downward so that it will come out flat. Some paper also has a front and back surface. If this is indicated on the paper's packaging, be sure to load the paper into the cassette face down.

Electrostatic properties

During the printing process the paper is electrostatically charged to attract the toner. The paper must be able to release this charge so that printed sheets do not cling together in the output tray.

Quality control

Uneven sheet size, corners that are not square, ragged edges, welded (uncut) sheets, and crushed edges and corners can cause the printer to malfunction in various ways. Pay particular attention to these considerations if you are choosing paper yourself.

Packaging

Select paper that is wrapped by the ream and then placed in a box. The best wrapping is one whose inner surface is coated to protect against humidity.

Specially treated paper

We recommend that you avoid using paper listed below which has been specially treated, even if it meets basic specifications. If you wish to use such paper, test a sample on the printer and check that printing quality is satisfactory before purchasing.

- Paper with a glossy finish
- Paper with sections cut out
- Paper which is embossed
- Paper with feed holes in it
- Paper with punch holes in it

Special Paper

This section explains printing on special paper. The page printer can use the following types of special paper.

- (1) Colored paper
- (2) Preprinted paper
- (3) Overhead projector transparencies
- (4) Postcards
- (5) Envelopes
- (6) Labels

When using the above types of paper, be sure to use products that are specified for use with photocopiers and/or page printers. Feed paper other than colored paper or pre-printed paper from the manual tray.

Since the composition and quality of special paper vary considerably, special paper is more likely than white bond paper to give trouble during printing. Special paper may be used with this printer if it meets the following conditions. Note that these types of paper differ greatly in their construction and quality, resulting in an increased chance of problems occurring during printing. No liability will be assumed if moisture etc. given off in printing on special paper causes harm to the machine or operator.

Note

Before purchasing any type of special paper, test a sample on the printer and check that printing quality is satisfactory.

Specifications for each type of special paper are given below.

Colored Paper

Colored paper should meet the same specifications as listed for white bond paper in page B-3. In addition, the pigments used in the paper must be able to withstand the heat of fusing during the printing process.

Preprinted Paper

The paper base of preprinted paper should meet basic specifications. The preprinted ink must be able to withstand the heat of fusing during the printing process, and do not use paper with any kind of surface treatment, such as the type of paper commonly used for calendars.

Overhead Projection (OHP) Film

OHP film must be able to withstand the heat of fusing during the printing process. Specifications are as follows.

OHP Film Specifications

Item	Specification
Tolerance of heat	Must tolerate at least 190°C (374°F)
Thickness	0.100 to 0.110 mm (3.9 to 4.3 mils)
Material	Polyester
Squareness of corners	90° ±0.2°

Notes

- Feed OHP film one at a time from the manual tray.
- Do not use film made from anything other than polyester.

Postcards

Use postcards weighing 90 to 128 g/m². Avoid using postcards whose printing surface has been coated. Any postcards of size 100 mm by 148 mm or larger may be used.

Envelopes

Envelopes made from paper weighing 60 to 79 g/m² may be printed using this printer.

It may not be possible to print evenly across the entire envelope's surface depending on its construction. Envelopes which are particularly thick may wrinkle as they come out of the printer. Test a sample envelope on the printer and check that printing quality is satisfactory before purchasing.

Envelopes with exposed adhesive cannot be used regardless of their type. Envelopes which use peel-off strips to cover adhesive also cannot be used as this little strip coming off inside the printer can result in major damage.

Envelopes which have been specially treated also cannot be used. For example, envelopes with string attached for sealing, envelopes with open windows, and envelopes with film covered windows cannot be used with this printer.

Labels

Labels cause trouble due to their construction. When selecting labels, look for labels whose adhesive will not come in contact with the printer and whose base will not peel off easily. Major damage to the printer may result if adhesive gets on the drum or rollers or if a peeled off label gets stuck inside the printer.

Note

Printing quality and possible trouble when printing labels are entirely the responsibility of the user.

Appendix C

Host Computer

Interface

This appendix describes the signals used in the laser printer's parallel interface and serial interface (option [IB-10]). It lists pin assignments, signal functions, timings, connector specifications, and voltage levels. Finally, it explains the use of the printer in a multi-computer environment.

Parallel Interface

Parallel interface communication modes

The printer features the fast data transmission mode on the parallel interface. The parallel interface mode can be changed by using the PRESCRIBE FRPO 00 command. See the *Programming manual* (in the Kyocera Digital Library CD-ROM) for details.

Note

Use a parallel printer cable that complies with the IEEE1284 standards.

Nibble (high) (FRPO 00, 5; [default])

High speed data communication is used in compliance with the IEEE 1284 standard. Ordinarily, you should leave this setting unchanged.

Auto (FRPO 00, 70;)

The printer automatically changes its communication mode to the one the host computer is currently using.

Normal (FRPO 00, 0;)

The printer uses the communication method described by the normal definitions of the Centronics interface.

High-speed (FRPO 00, 1;)

This mode enables faster data reception from the host computer by the normal definitions of the Centronics interface..

Interface Signals

The pins of the parallel interface connector carry the signals listed in Table C.1 . Asterisks in the table indicate signals that are active low. The table also indicates whether each signal is incoming or outgoing with respect to the printer.

Table C. 1. Parallel Connector Pin Assignments

Pin	In/out	Description
1	In	Strobe* [nStrobe]
2	In	Data 0 [Data 1]
3	In	Data 1 [Data 2]
4	In	Data 2 [Data 3]
5	In	Data 3 [Data 4]
6	In	Data 4 [Data 5]
7	In	Data 5 [Data 6]
8	In	Data 6 [Data 7]
9	In	Data 7 [Data 8]
10	Out	Acknowledge* [nAck]
11	Out	Busy [Busy]
12	Out	Paper Empty [PError]
13	Out	On-Line (Select) [Select]
14	In	Auto-feed [nAutoFd]
15	—	Not connected
16	—	0V DC
17	—	Chassis GND
18	—	+5V DC
19	—	Ground return
20	—	Ground return
21	—	Ground return
22	—	Ground return
23	—	Ground return
24	—	Ground return
25	—	Ground return

(Continued on next page)

Pin	In/out	Description
26	—	Ground return
27	—	Ground return
28	—	Ground return
29	—	Ground return
30	—	Ground return
31	In	Ignored [nInit]
32	Out	Error*, returns error status if FRPO O2=2 [nFault]
33	—	—
34	—	Not connected
35	Out	Power Ready
36	In	Select In [NSelectIn]

[]: Signal names in the Auto mode (IEEE 1284). In the Auto mode, these signals are bi-directional.

Detailed descriptions of the signals follow.

Strobe* [nStrobe] (Pin 1)

A negative-going Strobe* pulse causes the printer to read and latch the data on the Data 0 [1] to Data 7 [8] signal lines.

Data 0 [1] to Data 7 [8] (Pins 2 to 9)

These eight signals form the data byte sent from the host computer to the printer. Data 7 [8] is the most significant bit.

Acknowledge* [nAck] (Pin 10)

This negative-going pulse acknowledges the previous character received by the printer. Acknowledge* pulses are sent only when Busy is low.

Busy [Busy] (Pin 11)

This signal is high when the printer is busy and low when it is able to accept more data. Every high-to-low transition is followed by an Acknowledge* pulse.

Paper Empty [PError] (Pin 12)

This signal goes high when the printer runs out of paper.

On-Line [Select] (Pin 13)

This signal is high when the printer is on-line and low when the printer is off-line. It goes low when the upper unit is raised, or when the **ON LINE/STATUS** key is pressed to set the printer off-line.

Note

The Paper Empty and On-Line signals are not used unless enabled by the FRPO command (O2 parameter).

Auto-Feed [nAutoFd] (Pin 14)

This signal is used in the Epson version of the Centronics interface to receive a carriage return. In high-speed mode, it is used as an interrupt.

+5V DC (Pin 18)

This line is connected to the printer's +5V DC line (+5V \pm 0.5V, 250 mA).

Prime [nInit] (Pin 31)

This signal is used in the standard Centronics interface to enable the computer to reset the printer. It is ignored by the printer.

Error* [nFault] (Pin 32)

When the high-speed parallel line control is on (FRPO O2=2), this line returns error status.

Auxiliary output 1 (Pin 33)

This signal line is not used.

Power Ready (Pin 35)

This signal is high when the printer's power is on.

Select In [NSelectIn] (Pin 36)

This signal is used in some versions of the Centronics interface to enable the computer to force the printer on-line. In high-speed mode, it is used as an interrupt.

Serial (RS-232C/RS-422A) Interface (Option)

Mounting the optional serial interface kit (IB-10) to the printer enables connection to a computer with a RS-232C or RS-422A standard serial interface.

RS-232C interface

Interface Signals

The pins of the printer's RS-232C interface connector carry the signals listed in Table C.2. The table also indicates whether each signal is incoming or outgoing with respect to the printer.

Table C. 2. RS-232C Signal Pin Assignments

Pin	In/out	Signal	Description
1	–	FG	Frame ground
2	Out	TXD	Transmit Data
3	In	RXD	Receive Data
4	Out	RTS	Request To Send
5	In	CTS	Clear To Send
6	In	DSR	Data Set Ready
7	–	SG	Signal Ground
20	Out	DTR	Data Terminal Ready

Brief descriptions of the signals follow.

FG – Frame Ground – (Pin 1)

This pin is connected directly to the printer frame.

TXD – Transmit Data – (Pin 2)

This output carries asynchronous data sent by the printer to the computer. It is used mainly in handshaking protocols.

RXD – Receive Data – (Pin 3)

This input carries serial asynchronous data sent by the computer to the printer.

RTS – Request To Send – (Pin 4)

This output is always held high (above 3 volts).

CTS – Clear To Send – (Pin 5)

DSR – Data Set Ready – (Pin 6)

Unused.

SG – Signal Ground – (Pin 7)

All signals can transmit between the printer and the host computer to send each signals with a signal ground.

DTR – Data Terminal Ready – (Pin 20)

This output is used as a buffer nearly-full handshake line. It is held high (above 3 volts) when the buffer can accept more data.

RS-232C Interface Voltage Levels

The voltage levels of the interface signals conform to EIA RS-232C specifications. SPACE is from 3 volts to 15 volts. MARK is from –3 volts to –15 volts. Voltages between –3 volts and 3 volts are undefined.

RS-422A interface

The serial interface was set to RS-232C mode before leaving the factory. However, by changing the jumper connector on the IB-10 interface board, the interface can be changed to RS-422A mode.

In RS-232C mode, the printer can be connected to a personal computer (or similar device) equipped with an RS-232C serial interface. (The serial interface is set to RS-232C before leaving the factory.)

In RS-422A mode, the printer can be connected to a personal computer (or similar device) equipped with an RS-422A serial interface.

Note

The changing of the jumper connector should be carried out only by a Kyocera authorized dealer or Kyocera certified technician. Kyocera shall not be liable for damage due to improper changing of the jumper connector.

Interface Signals

The pins in the printer's RS-422A interface connector carry the signals listed in Table C.3.

Table C.3. RS-422A Signal Pin Assignments

Pin	In/out	Signal	Description
1	–	FG	Frame ground
3	In	RDA	Receive data Inverted
7	–	SG	Signal ground
9	Out	SDA	Send data Inverted
10	Out	SDB	Send data
11	–	–	+5V DC
18	In	RDB	Receive data

Overview of Signals (RS-422A)

FG – Frame Ground – (Pin 1)

This pin is connected directly to the printer frame.

SG – Signal Ground – (Pin 7)

All signals can transmit between the printer and the host computer to send each signals with a signal ground.

RDB – Receive Data – (Pin 18)

RDA – Receive Data Inverted – (Pin 3)

These pins carry asynchronous data sent from the computer to the printer. (differential input)

SDB – Send Data – (Pin 10)

SDA – Send Data Inverted – (Pin 9)

These pins carry asynchronous data sent from the printer to the computer. (differential output)

RS-422A interface voltage levels

The interface signal voltage levels conform with the EIA RS-422A standard. The differential voltage varies from 200 mV to 6V.

SERIAL Connector

The connector marked "IOIOI " (RS-232C/RS-422A) on the rear panel is a DB-25S connector. Use a DB-25P connector (or equivalent) for the connector on the cable.

RS-232C/RS-422A Protocol

A protocol is a set of rules the computer follows in sending data to the printer. The RS-232C/RS-422A parameters are stored in battery backed-up memory. They are indicated on the status printout. They can be changed by the FRPO (firmware reprogram) command described in the *Programming Manual*. The parameters and their identification codes are given below.

H1: Baud rate

Parameter value	Baud rate
12	1200
24	2400
48	4800
96	9600
19	19200
38	38400
57	57600
11	115200

The factory setting is 9600 baud.

H2: Data bits

7 or 8, factory-set to 8.

H3: Stop bits

1 or 2, factory-set to 1.

H4: Parity

Parameter value	Meaning
0	None
1	Odd
2	Even
3	Ignore

The factory setting is “None” (0 on the status printout).

H5: Protocol logic

Parameter value	Meaning
0	Combination of 1 and 3 below
1	DTR/DSR, positive logic
2	DTR/DSR, negative logic
3	XON/XOFF
4	ETX/ACK
5	XON/XOFF recognized only as protocol

The factory setting is 0.

H6: Buffer nearly-full threshold

This is a percentage from 0 to 99. The factory setting is 90.

H7: Buffer nearly-empty threshold

This is a percentage from 0 to 99. The factory setting is 70.

The factory settings of the buffer nearly-full and nearly-empty thresholds (H6 and H7) are subject to change without notification.

The gap between the nearly-full and nearly-empty thresholds allows the computer to send a fairly large amount of data in a continuous stream.

H8: Received-data buffer size

This is the size of the input buffer, specified in units of 10K bytes. The factory-set value is 6 meaning 60K bytes.

Note

Since DTR/DSR protocol is not used with the RS-422A standard, select a parameter value other than 0, 1, or 2 for the H5 setting when using the RS-422A interface.

PRESCRIBE FRPO D0 command

The PRESCRIBE FRPO D0 command is provided to allow manipulating XON/XOFF when an error has occurred on the serial interface. The following table summarizes the error status corresponding to different D0 values.

		Serial interface error	
		error not handled	error handled
Timing of XON transfer to host while Ready or Waiting	XON sent every 3-5 seconds	D0 = 0 (default)	D0 = 1
	XON not sent	D0 = 10	D0 = 11

RS-232C Cable Connection

Preparing an RS-232C Cable

After obtaining an RS-232C cable, check that it is wired correctly, referring to the pin assignment table in **Appendix C**. If you have an IBM communication adapter cable type 1502067, you will have to resolder the wiring at the printer end of the cable. The procedure is as follows.

1. Unscrew the plastic cover from the printer end of the cable.
2. Next to each of the wires inside the cable is a bare shield wire. Solder all these shield wires together into a single bundle.
3. Using a section of flat wire about 3 mm wide and 15 mm long, connect the bundle of shield wires to the metal facing of the connector. Check that the solder connections are secure.
4. Desolder wires 2 and 3, then resolder them in crossed configuration. Solder wire 2 to pin 3 and wire 3 to pin 2. Cover the solder joints with thermofit tube.
5. Cut wires 4, 5, 6, and 20.
6. Solder wires 5 and 6 together and connect them to pin 20. Cover the solder joints with thermofit tube. Leave wire 4 unconnected.
7. Tape all remaining loose ends, or seal them with thermofit tube.
8. Screw the plastic cover back on.

Connecting the Printer to the Computer

1. Check that the power of both the printer and computer is switched off.
2. Discharge yourself by touching a metal object such as a doorknob.
3. Remove the plastic cap from the printer's RS-232C interface connector.
4. Plug the printer end of the RS-232C interface cable into the printer's RS-232C connector and screw it in place.
5. Plug the other end of the cable into the computer's RS-232C interface connector.
6. Switch on the printer's power.
7. The printer's RS-232C parameters are factory-set to the following values:

Baud rate=9600 bps, Data bits (character length)=8 bits,
Stop bits=1, Parity=None

The three RS-232C protocols are XON/XOFF and DTR. The printer performs all three of them simultaneously, using positive logic for DTR.

8. Set the computer to the same parameters as the printer. On many computers this can be done by setting DIP switches before power is turned on. Another method is as follows:

In DOS, enter the following commands:

```
C:>MODE COM1:96,N,8,1,P  
C:>MODE LPT1:=COM1
```

To test the interface, then enter:

```
^P (Press the P key while holding down the Ctrl key.)  
C:>DIR  
^P (Press the P key while holding down the Ctrl key.)
```

The software settings made by the procedures above are temporary. On most computers, permanent settings must be made with DIP switches.

If you want to use a different baud rate or change any of the other RS-232C parameters, you can use the printer's FRPO (firmware reprogram) command. See the *Programming Manual* for details.

Appendix D Indicators

Indicators

Whether the indicator is lit, flashing or off is indicated as shown in the following diagram. Although there is fast flashing and slow flashing, they are not distinguished diagrammatically.



Waiting

ON LINE / A4 DATA / LTR MANUAL / LGL CASSETTE / OTHERS JAM TONER	The six indicators flash in sequence.
---	---------------------------------------

Off line

ON LINE / A4 DATA / LTR MANUAL / LGL CASSETTE / OTHERS JAM TONER	The printer is off-line. The printer stores but does not print received data. (In this example, the printer's cassette is selected).
---	---







Ready (On line)

ON LINE / A4 DATA / LTR MANUAL / LGL CASSETTE / OTHERS JAM TONER	The printer is ready to print. (In this example, the printer's cassette is selected).
---	--







Receiving data

ON LINE / A4 DATA / LTR MANUAL / LGL CASSETTE / OTHERS JAM TONER	The printer is receiving data. (In this example, the printer's cassette is selected).
---	--







Processing data

 ON LINE / A4	The printer is processing data, or the printer is waiting for a code or command that the job is over. (In this example, the printer's cassette is selected).
 DATA / LTR	
 MANUAL / LGL	
 CASSETTE / OTHERS	
 JAM	
 TONER	







Sleeping







 ON LINE / A4	The printer has entered the sleeping mode. The on-line mode is restored when any of the keys is pressed or data is sent to the printer.
 DATA / LTR	
 MANUAL / LGL	
 CASSETTE / OTHERS	
 JAM	
 TONER	

Adding paper







 ON LINE / A4	The cassette is empty. Add paper to the paper cassette or add a sheet of paper to the manual feed tray. (In this example, the printer's cassette is selected).
 DATA / LTR	
 MANUAL / LGL	
 CASSETTE / OTHERS	
 JAM	
 TONER	

Manual feed







 ON LINE / A4	Paper is set on the manual feed tray after data is sent to the printer. To start printing, press the ON LINE/STATUS key (twice).
 DATA / LTR	
 MANUAL / LGL	
 CASSETTE / OTHERS	
 JAM	
 TONER	

 ON LINE / A4	Paper is set on the manual feed tray before data is sent to the printer. To start printing, press the ON LINE/STATUS key (twice).
 DATA / LTR	
 MANUAL / LGL	
 CASSETTE / OTHERS	
 JAM	
 TONER	







Selecting paper size

 ON LINE / A4	The ON LINE/A4, DATA/LTR, MANUAL/LGL, and CASSETTE/OTHERS indicators are toggled to light one after another as the SHIFT+FEED/SIZE key is pressed repeatedly.
 DATA / LTR	
 MANUAL / LGL	
 CASSETTE / OTHERS	
 JAM	
 TONER	







Paper jam

 ON LINE / A4	<p>Paper jam. Refer to the Installation Manual or Chapter 5 in this manual, and remove the jammed paper. (In this example, the printer's cassette is selected).</p>
 DATA / LTR	
 MANUAL / LGL	
 CASSETTE / OTHERS	
 JAM	
 TONER	







Memory overflow

 ON LINE / A4	<p>The total amount of the data received by the printer exceeds the printer's internal memory. Try adding more memory (expansion RAM). Press the ON LINE/STATUS key to resume printing. You can abandon printing by the SHIFT key and SLEEP/CANCEL key.</p>
 DATA / LTR	
 MANUAL / LGL	
 CASSETTE / OTHERS	
 JAM	
 TONER	













Top cover open

 ON LINE / A4	<p>The printer's top cover is open. Close firmly. (In this example, the printer's cassette is selected).</p>
 DATA / LTR	
 MANUAL / LGL	
 CASSETTE / OTHERS	
 JAM	
 TONER	

Print Overrun

 ON LINE / A4	<p>The data transferred to the printer was too complex to print on a page. Press the ON LINE/STATUS key to resume printing. (The page may break in some pages.) You can abandon printing by the SHIFT key and SLEEP/CANCEL key. Note: Send the following command to the printer after this error has occurred: !R! FRPO R5, 1; EXIT; to release the page protect mode.</p>
 DATA / LTR	
 MANUAL / LGL	
 CASSETTE / OTHERS	
 JAM	
 TONER	



















Toner status

























 ON LINE / A4	<p>Toner is almost exhausted. (In this example, the printer's cassette is selected).</p>
 DATA / LTR	
 MANUAL / LGL	
 CASSETTE / OTHERS	
 JAM	
 TONER	
 ON LINE / A4	<p>Toner exhausted. Replace the toner container using a new toner kit. The printer does not operate. (Refer to the Installation Manual or Chapter 4 in this manual, and replace the toner container.) (In this example, the printer's cassette is selected).</p>
 DATA / LTR	
 MANUAL / LGL	
 CASSETTE / OTHERS	
 JAM	
 TONER	







Call-service person errors

When the indicators alternate between two different flashing states as diagrammed below, one of the Call-service person errors is meant. Contact your Kyocera dealer.

 Lit  Off

 ON LINE / A4  DATA / LTR  MANUAL / LGL  CASSETTE / OTHERS  JAM  TONER	Main motor error (E1 error) Please contact your Kyocera dealer.
 ON LINE / A4  DATA / LTR  MANUAL / LGL  CASSETTE / OTHERS  JAM  TONER	Scanner motor error (E2 error) Please contact your Kyocera dealer.
 ON LINE / A4  DATA / LTR  MANUAL / LGL  CASSETTE / OTHERS  JAM  TONER	Scanner pin-photo error (E3 error) Please contact your Kyocera dealer.

 ON LINE / A4  DATA / LTR  MANUAL / LGL  CASSETTE / OTHERS  JAM  TONER	Fuser error (E4 error) Please contact your Kyocera dealer.
 ON LINE / A4  DATA / LTR  MANUAL / LGL  CASSETTE / OTHERS  JAM  TONER	Toner motor error (E9 error) Please contact your Kyocera dealer.
 ON LINE / A4  DATA / LTR  MANUAL / LGL  CASSETTE / OTHERS  JAM  TONER	Controller check sum error (F1 error) Please contact your Kyocera dealer.
 ON LINE / A4  DATA / LTR  MANUAL / LGL  CASSETTE / OTHERS  JAM  TONER	Controller RAM read/write error (F2 error) Please contact your Kyocera dealer.

	ON LINE / A4	Controller system error (F3 error) Please contact your Kyocera dealer.
	DATA / LTR	
	MANUAL / LGL	
	CASSETTE / OTHERS	
	JAM	
	TONER	

Index**C**

Cap 4-2
 Cleaning..... 4-9
 Cleaning cloth 4-2
 Control keys..... 2-4
 Control panel..... 2-2

D

Dispose of the old toner container 4-5
 Drum 4-9

E

Ecoprint..... 2-7, 5-6
 Envelope B-11
 Environmental requirements
 of the page printer..... 1-2
 Error Indications..... 5-11
 Expanding memory 1-32

F

Face-down output tray 1-9
 Face-up output tray..... 1-9, 1-20
 Fonts..... 3-1

G

General guide..... 5-2

I

Indicator..... 2-3, 5-8, D-1
 Interface signals C-3
 Interface C-1

K

KIR..... 2-5
 KPDL..... 3-1, 3-3

L

Laser scanner cover glass 4-10
 List of fonts 3-3
 Load limit 1-18

M

Maintenance Indications.....5-8
Maintenance.....4-1
Manual feed tray..... 1-9, 2-8
Manual paper feeding.....2-8
Moving the printer.....1-8

O

OHP film..... B-10

P

Paper feeder.....1-12
Paper jam.....5-12
Paper specifications B-3
Parallel interface..... C-2
Parallel interface connector.....1-22
Places to avoid.....1-2
Plastic waste bag4-2
Power cord 1-7, 1-23
Print quality problem.....5-4
Printer driver.....1-26
Printer problems.....5-2
Printer specifications A-1
Process unit.....4-9

R

Registration roller..... 4-10
Right paperB-4

S

Scalable fonts 3-2
Setup and connections 1-11
Setup..... 1-11
SIMM..... 1-32
Special paperB-9
Status page..... 2-6
Sub-tray 1-9, 2-9
Surrounding space..... 1-5

T

Toner container release lever 4-4
Toner container replacement interval 4-2
Toner container..... 1-7, 4-2
Toner kit..... 4-2
Troubleshooting 5-1

U

Unpacking..... 1-6

W

Windows 1-26